

# DTF-521

interactive pen display

Installation Guide & User's Manual



Wacom DTF-521 interactive pen display  
Installation Guide & User's Manual  
English version 2.0 October 25, 2007  
Copyright © Wacom Co., Ltd., 2007

All rights reserved. No part of this manual may be reproduced except for your express personal use. Wacom reserves the right to revise this publication without obligation to provide notification of such changes. Wacom does its best to provide current and accurate information in this manual. However, Wacom reserves the right to change any specifications and product configurations at its discretion, without prior notice and without obligation to include such changes in this manual.

DuoSwitch is a trademark, and Wacom is a registered trademark of Wacom Co., Ltd.

Microsoft, Windows, and Vista are either registered trademarks or trademarks of Microsoft Corporation in the United States and/or other countries. Apple, the Apple logo, and Macintosh are trademarks of Apple Computer, Inc., registered in the U.S. and other countries.

Any additional company and product names mentioned in this documentation may be trademarked and/or registered as trademarks. Mention of third-party products is for informational purposes only and constitutes neither an endorsement nor a recommendation. Wacom assumes no responsibility with regard to the performance or use of these products.

# **INTRODUCTION AND OVERVIEW**

The Wacom® DTF-521 interactive pen display combines the benefits of a Liquid Crystal Display (LCD) with the control, comfort, and productivity of Wacom's cordless, battery-free pen technology. This gives you a direct pen-on-screen interface for your computer.

The basic components of the DTF-521 include a Wacom pen tablet internally mounted behind a 15.0" diagonal TFT color display, and a Wacom pen.

The DTF-521 also comes equipped with a VGA pass-thru (ANALOG RGB OUT) port, enabling you to simultaneously connect a VGA monitor or projector to the pen display.

This manual describes how to install the DTF-521 hardware and software. It also describes how to use the DTF-521 and pen. **Please follow all instructions carefully.**

**The computer treats the DTF-521 as two separate devices (the display and the pen tablet).**

Therefore, the installation process is completed in two stages:

- First install the DTF-521 as a display.
- Then install the DTF-521 as a pen tablet.

Both stages require hardware and software installations and adjustments. **Please follow all instructions carefully.**

**IMPORTANT:** You MUST install the Wacom pen tablet driver software for correct pen-on-screen functionality.

To learn about using the Pen Tablet control panel to customize your pen display tablet and pen settings on Windows or Macintosh computers, see *Customizing* on page 19.

The following kinds of information are not included with this product: information about your specific computer hardware or operating system, or information about your application software. Your best source for this information is the set of manuals and discs that came with your hardware, operating system, or application.

# PRECAUTIONS

To ensure the safe usage of your product, be sure to follow all instructions, cautions, and warnings found within this manual. Failure to do so could cause the loss of data or damage to your computer. Failure to do so could also void your warranty, in which case Wacom shall have no responsibility to repair or replace the product.



## **WARNING**

This symbol indicates an item that, if disregarded, may lead to loss of human life or serious injury.



## **CAUTION**

This symbol indicates an item that, if disregarded, may lead to human injury or damage to personal property.

Exercise due care and diligence whenever engaging in a described action.

## PHYSICAL LOCATION



### **WARNING**

**Do not use the DTF-521 interactive pen display in a facility control system that requires extremely high reliability;** it may cause other electronic devices to malfunction, or other devices may cause the pen display to malfunction. Where use is prohibited, power off the DTF-521 to prevent the possibility of it causing other electronic devices to malfunction. Wacom does not accept any liability for direct or consequential damages. For details, please refer to your Warranty located at the end of this guide.

## ENVIRONMENT



### **CAUTION**

#### **Temperature and humidity**

- Operating temperature and humidity: 5° to 35°C, 20 to 80% RH
- Storage temperature and humidity: -10° to 60°C, 20 to 90% RH

#### **Do not use or store the pen display where:**

- Temperature changes are severe or exceed specifications (e.g., outdoors or inside a vehicle).
- The pen display and pen are exposed to direct sunlight or heat from an appliance, or are exposed to water or any other kind of liquid.



### **CAUTION**

**Do not use the pen display in a dusty environment;** this may damage the unit.

## USAGE



### WARNING

**Only use the power adapter that came with the DTF-521.** If a different type of power adapter is used, the DTF-521 will not work properly or may be damaged. **Using a different type of power adapter also has the potential to result in fire.** Use of a different power adapter will void your warranty.



### CAUTION

**Be sure to use a grounded power source when applying power to the DTF-521.**



### CAUTION

**Do not connect or disconnect the video or power cables while the DTF-521 or your computer are turned on;** this may damage the display or computer video card. In this case, Wacom shall have no responsibility to repair or replace the product.



### CAUTION

**This product is for use with a VGA video card;** using an inappropriate video card may damage the DTF-521.



### CAUTION

**Do not block the rear panel ventilation holes;** this may overheat and damage the unit.

**When not using the DTF-521 for long periods of time, unplug the power adapter from the AC outlet.**

## HANDLING



### WARNING

**High Voltage. Do not open or disassemble the DTF-521 pen display. There is a risk of electrical shock when the casing is open.** This will also void your warranty and Wacom shall have no responsibility to repair or replace the product.



### WARNING

**If the LCD screen has been damaged, DO NOT touch any liquid that may be leaking from it;** this liquid is an irritant. In case of contact with skin, eyes, or mouth, rinse immediately with running water for at least 15 minutes or more. If contact is made with the eyes or mouth, also consult a physician.



### WARNING

**(Hg) – LAMP(S) INSIDE THIS PRODUCT CONTAIN MERCURY AND MUST BE RECYCLED OR DISPOSED OF ACCORDING TO LOCAL, STATE OR FEDERAL LAWS.**

**The DTF-521 pen display has a backlight which contains mercury (Hg).** Be sure to dispose of properly, and to manage any disposal of this unit in accordance with your local ordinances and laws.



### WARNING

**Prevent children from swallowing the pen tip or side switch.** The pen tip or side switch may accidentally be pulled out if children are biting on them.



### CAUTION

**Do not disassemble the pen.** This may cause the device to malfunction. In this case, Wacom shall have no responsibility to repair or replace the product.



### CAUTION

**Do not scratch the display screen.** Avoid placing sharp objects on the display screen surface.



### CAUTION

**When adjusting the tilt angle of the pen display, be careful to avoid catching your finger in the gap of the movable portion of the stand.**



### CAUTION

**Do not lift the DTF-521 by the stand; this may damage the stand mechanism.** When lifting or moving the pen display, always do so by grasping the main body casing.



### CAUTION

**Avoid intensive shock or vibration to the DTF-521 or the pen.** Hitting or dropping the pen display may damage the display screen or other components.



CAUTION

**Do not put heavy articles on the pen display or push against it with a strong force;** this may damage the display screen or bend the stand.



CAUTION

**Do not place heavy articles on the DTF-521 cabling, repeatedly bend the cables sharply, or apply heavy stress to the cable connectors;** this may damage the unit or cabling.



CAUTION

**If the pen tip becomes sharp or angular, it may damage the coating on the display screen.** Please replace the pen tip if necessary.



CAUTION

**Do not use any organic solvent (e.g., alcohol) or even mild detergent to clean the display screen. Use of these cleaners can damage the coating on the screen. Please note that damage of this kind is not covered by the manufacturer's warranty.**

- To clean the display screen, use an anti-static cloth or a slightly damp cloth. When cleaning, apply only a light amount of pressure to the display screen and do not make the surface wet.
- To clean the pen display casing or pen, use a soft cloth with mild detergent (such as dish washing liquid) diluted with water.
- Before cleaning, always disconnect your product from the AC power source.



CAUTION

**Do not expose the DTF-521 to high voltage electrostatic discharges or to a build-up of an electrostatic charge on the LCD screen.** This may result in a temporary discoloration and blotching of the display. If discolorations occur, leave the display on and the discolorations should disappear within a few hours.



**Reuse, recycling and recovery.** You are urged to recycle this product when replacing it with a newer product or when it has outlived its useful life by bringing it to an appropriate collection point for recyclable materials in your community or region. By doing this, you can help improve the environment of your community as well as minimize the potential negative effects created, should any hazardous substance that may possibly be present within waste material reach the environment during the disposal process.

Within the European Union, users are required not to dispose of Waste Electrical and Electronic Equipment (WEEE) as unsorted municipal waste, according to the Directive 2002/96/EC of the European Parliament and of the Council of 27 January 2003, or the corresponding local laws of the Member States. Products for which this is applicable will be marked with the WEEE symbol shown at the beginning of this note unless this is not feasible because of the size or the function of the product. Wacom products are subject to the Directive 2002/96/EC and therefore you should always collect them separately and bring them to the appropriate collection point in your community or region.

Wacom pen display products comply with the European Union RoHS Directive 2002/95/EC (RoHS Directive).

# CONTENTS

<b>Introduction and overview</b> .....	<b>1</b>
<b>Precautions</b> .....	<b>2</b>
Physical location .....	2
Environment .....	2
Usage .....	3
Handling .....	3
<b>Your new DTF-521</b> .....	<b>7</b>
Package contents .....	7
Interactive pen display components .....	8
Front view .....	8
Rear view .....	9
<b>Installation</b> .....	<b>10</b>
System requirements .....	10
Step 1: LCD monitor installation .....	11
LCD monitor cabling diagram .....	12
Step 2: Pen tablet installation .....	14
USB cable installation .....	14
Pen tablet cabling diagram .....	14
Software installation .....	15
<b>Working with your DTF-521</b> .....	<b>16</b>
Setting up your work area .....	16
Using the pen .....	17
Pen components .....	17
Pen operations .....	18
<b>Customizing</b> .....	<b>19</b>
Opening the control panel .....	19
Control panel overview .....	20
Customizing the pen .....	20
Calibrating the DTF-521 .....	22
Customizing the Pop-up Menu .....	23
Control panel details .....	24
Adjusting double-click .....	24
Customizing the side switch button functions .....	24
Adjusting the display .....	27
Factory presets, auto-sync, and user settings .....	27
On Screen Display (OSD) settings .....	27
Adjusting pitch and phase .....	30
Power saving .....	31

<b>Troubleshooting</b> .....	<b>32</b>
Testing the DTF-521 .....	32
Display troubleshooting .....	34
General display problems .....	34
VGA problems .....	35
Pen tablet troubleshooting .....	36
General problems .....	36
Windows-specific problems .....	40
Macintosh-specific problems .....	40
Technical support options .....	41
Obtaining driver downloads .....	42
<b>Appendix</b> .....	<b>43</b>
Caring for the DTF-521 .....	43
Cleaning .....	43
Replacing the pen tip .....	44
Using an alternate mount or stand .....	45
Pen and digital ink capabilities in Windows Vista .....	46
About the Windows Vista Tablet PC Input Panel .....	47
Uninstalling the DTF-521 .....	48
Product specifications .....	49
General specifications .....	49
Display .....	49
Pen tablet .....	50
Power adapter .....	50
Pen (model FP-320) .....	50
Ordering parts and accessories .....	50
Radio and television interference .....	51
Federal Communications Commission (FCC) notice .....	51
Industry Canada (Canada only) .....	52
CE declaration .....	52
Warranty (Worldwide, Except for Europe, Africa and Middle East) .....	53
Warranty (Europe, Africa and Middle East) .....	55



# YOUR NEW DTF-521

## PACKAGE CONTENTS

Carefully unpack all items and place them on a desktop or stable work surface. Verify that your package contents are complete.

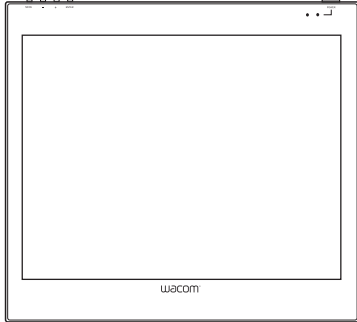

DTF-521 interactive pen display, main unit

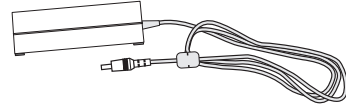

Power adapter and power cable  
(POW-A096 and SCD-A039-01 for USA)  
(POW-A096 and SCD-A038-01  
or SCD-A040-01 for Europe)

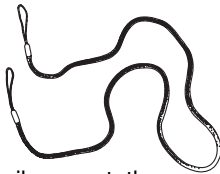
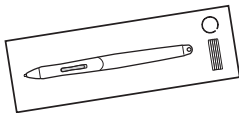

Pen with replacement nibs, pen tether,  
tether connection ring, and attachment screw  
(FP-320, PKB-A016, MHO-A052, and MNE-A061)

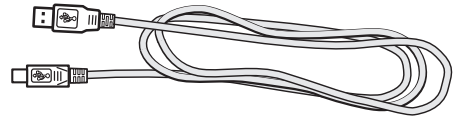

USB cable (STJ-A250)



Installation Guide & User's Manual  
(this manual)

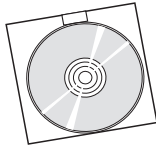

Wacom Pen Tablet Driver CD  
(contains the driver software)

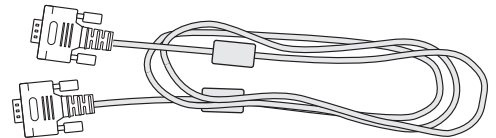

VGA to VGA cable (STJ-A228)

**Note:** Images not shown to scale. Some product configurations may come with different pens having no side switches. Some configurations may include additional CDs or DVDs containing application software. To install these applications, review the instructions that came with those CDs or DVDs. Retain the package box for use when storing or shipping the DTF-521.

# INTERACTIVE PEN DISPLAY COMPONENTS

Your product has many features and components with which you will want to become familiar.

## FRONT VIEW

The display and tablet sensor function as an integrated output and input device. The display supports resolutions up to 1024 x 768 pixels at 16.2 million colors. The tablet sensor reports pen coordinates, pressure, and switch information.

### On Screen Display (OSD) controls

These controls, located on the upper edge of the tablet, enable you to adjust a variety of display settings. See *Adjusting the display* on page 27 for more information.

### Power LED

Lights blue when power has been supplied to the DTF-521 and a video signal is present.

Glowes orange when no video signal is detected by the DTF-521. (e.g., Your computer is turned off, starting up, or has entered a power management mode in which video signals are not sent.)

### Power switch

Turns power to the unit on or off.

### Status LED

Lights blue when the pen is in the active area of the pen display tablet and the pen tip is pressed. Note that the USB cable must also be plugged into an active USB port before the LED will light.

Use the integrated USB ports (one located on each side of the unit) to connect a USB device (e.g., a USB Flash Drive or a USB remote controller).

### Pen tray

Provides a convenient resting place for the pen. When the display stand is set to its lowest position, place your fingers beneath the tray (located on the bottom front edge) and slide it out.

Be sure to fully install the DTF-521 hardware and software before connecting any other devices to the unit.

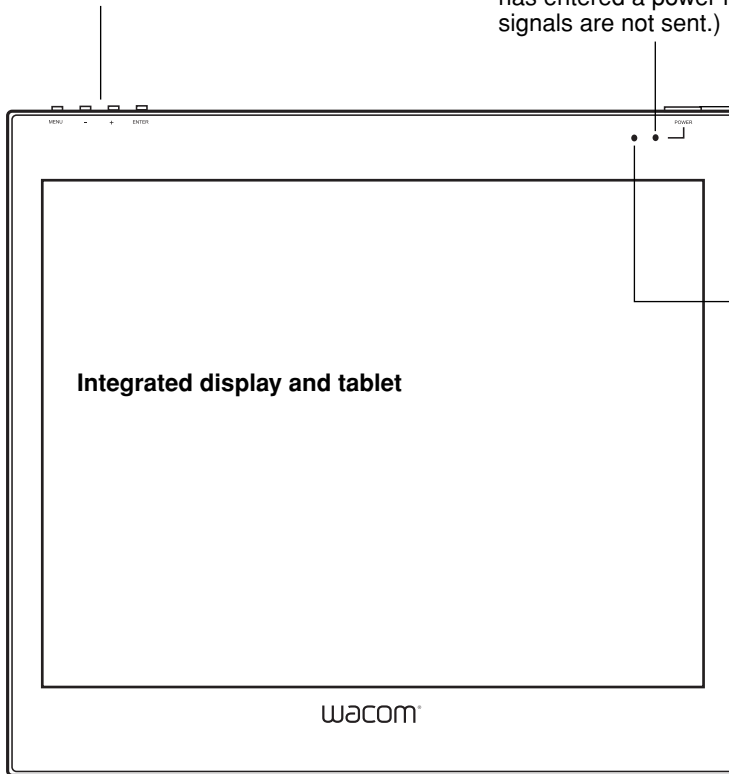

## REAR VIEW

### Pen storage compartment

For storage, insert one end of the pen into either side of the storage compartment. Then gently press the other end of the pen into the compartment.

For removal, press in on either end of the pen. This will pop the opposite end of the pen out of the compartment. You can then remove the pen.

### Kensington security slot

Allows easy attachment of a security cable.

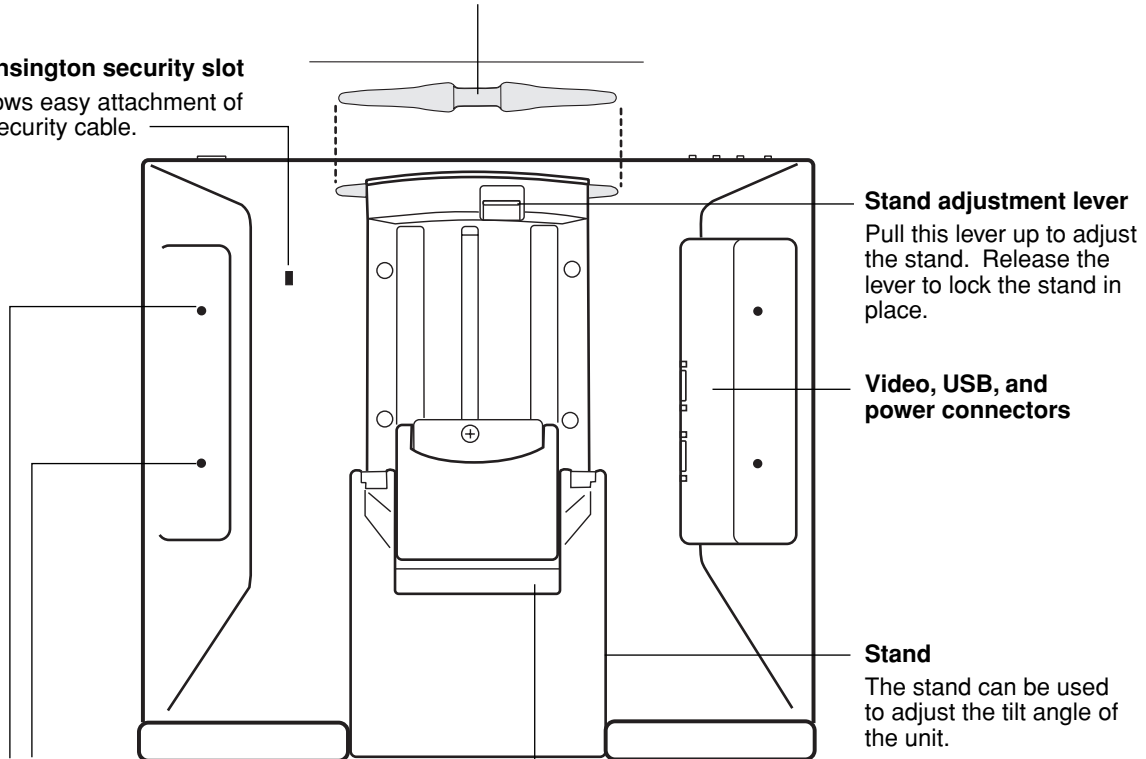

### Stand adjustment lever

Pull this lever up to adjust the stand. Release the lever to lock the stand in place.

### Video, USB, and power connectors

### Stand

The stand can be used to adjust the tilt angle of the unit.

### Pen tether attachment points

If you will be using the pen tether, use the tether attachment ring and small thumb screw to connect it to one of four attachment points located on the back of the unit.



**CAUTION** Be careful to avoid catching your finger in the gap of the movable portion of the stand.

**Important:** Always store the pen display on a stable surface or in its original packing carton when not in use. Be sure to adjust the stand to the low tilt position before packaging the DTF-521. If you do not close the stand, the notched mechanism may be damaged during transportation and storage.

Do not lift the unit by the stand; this may damage the stand mechanism. When lifting or moving the DTF-521, always do so by grasping the main body casing.

# INSTALLATION

## SYSTEM REQUIREMENTS

Before installing the DTF-521, make sure your computer meets the following minimum system requirements:

- **PC.** Windows Vista™, Vista X64, XP, XP x64, or 2000. VGA video connector, available USB port, and CD-ROM drive.
- **Macintosh.** OS X, v10.3.9 or greater. VGA video connector, available USB port, and CD-ROM drive.

**Notes:** The DTF-521 can be used alone or with another display. You may connect a second VGA device such as a monitor or LCD projector to the DTF-521 ANALOG RGB OUT port. When using this port, the second device will mirror the image on the DTF-521. Complete the DTF-521 installation before connecting a projection device to the unit.

Depending on the capabilities of your video card and operating system, you may be able to set up the DTF-521 as a mirrored, extended, or independent display. Refer to your video card documentation for more information on its capabilities.

When you are working with more than one monitor, the DTF-521 will map to the monitors based upon how your system is configured. By default, if you are in mirror mode, the pen tablet will map to the entire space on each display or monitor. Please refer to your hardware and operating system documentation for details on configuring your computer and operating system for use with multiple monitors.

**There are two primary steps to the installation process:**

- **Step 1: LCD monitor installation**
- **Step 2: Pen tablet installation**

**Be sure to follow ALL instructions carefully.**

## STEP 1: LCD MONITOR INSTALLATION

In the first stage of the installation process, the DTF-521 is installed as a monitor on your system. As you work through the first stage of the installation process, please refer to the *LCD monitor cabling diagram* on the following page when making cable connections.

**Important:** Do not connect the USB data cable until instructed to do so.

- Turn off your computer.

**Caution:** Never connect or disconnect the video or power cables while your computer or DTF-521 are powered on – this can damage the display or video card.

- If your computer has only one analog (VGA) video connector, you will need to unplug your previous monitor or add a second VGA card.
- Plug one end of the VGA cable into the DTF-521. Plug the other end of the cable into the VGA connector on your computer's video card. See – **A** – in the connection diagram on page 12. Be sure to tighten the thumbscrews on the connectors.
- Connect the power adapter to the DTF-521. Then connect the adapter's power cable and plug the adapter into an AC outlet. See – **B** – and – **C** –
- Turn on the DTF-521. The power LED will light orange.

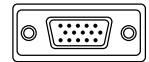

**VGA connector**

# LCD MONITOR CABLING DIAGRAM

Do not attach the USB data cable until instructed to do so.

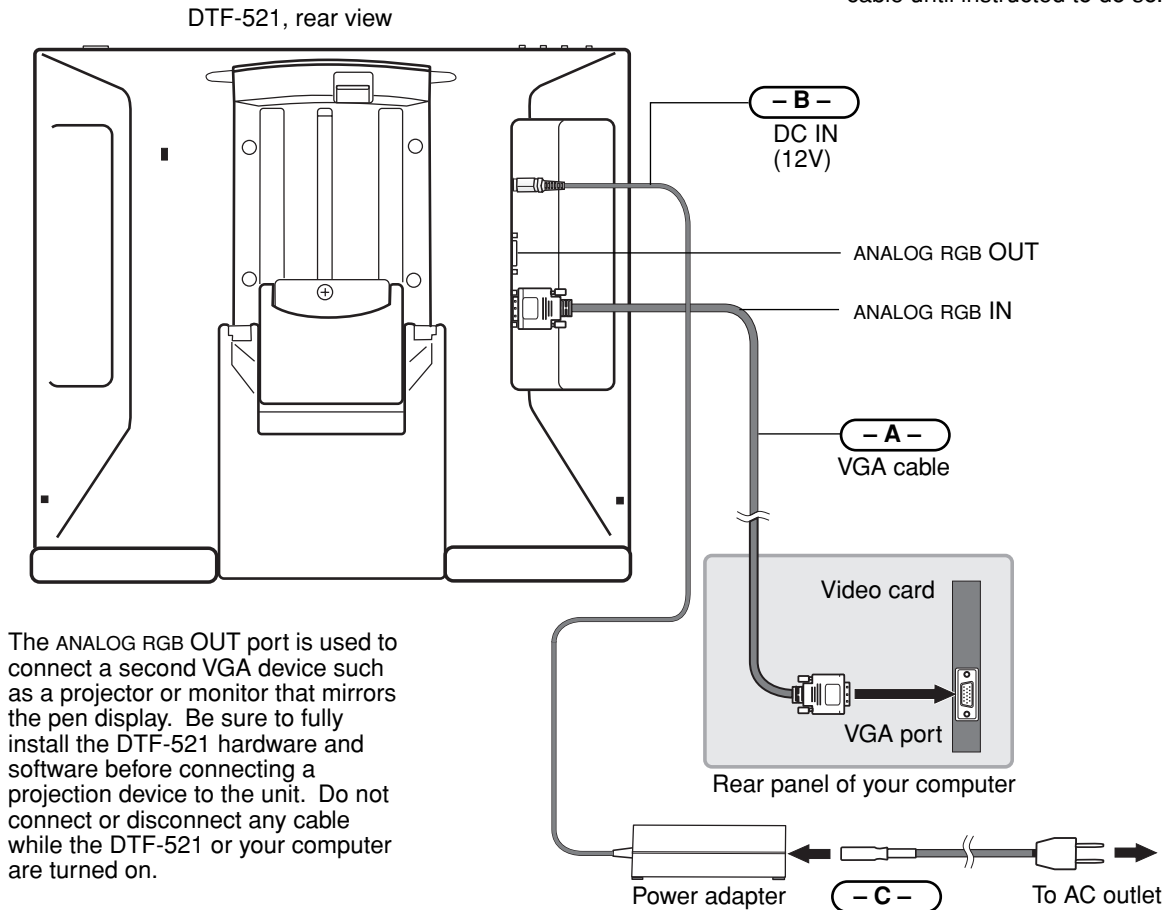

**CAUTION** Use only the power adapter that came with the DTF-521; use of an improper power adapter may damage the unit.

**Do not connect or disconnect the video or power cables while the DTF-521 or your computer are turned on – this can damage the display or computer video card.**

**Make sure that the display refresh rate does not exceed 70 Hz for XGA mode, or 75 Hz for other modes.**

- Next, turn on your computer.  
For Windows systems: The DTF-521 will automatically install as a default monitor.
- As necessary, configure the display control panel settings for the proper size and color resolution. The maximum (native) resolution of the DTF-521 is 1024 x 768 pixels. The display size and color resolution may be constrained by the capabilities of your video card. See the video card manufacturer's documentation for details.  
Windows: If you are using the DTF-521 as a secondary display, you may first need to enable the DTF-521 in your Display Properties control panel.
- To fine-tune the display, please refer to *Adjusting the display*, beginning on page 27 for more information.
- After the LCD monitor portion of the DTF-521 is working to your satisfaction, move on to *Step 2: Pen tablet installation* to install the pen tablet portion of the DTF-521. For troubleshooting tips, see page 32.

**Notes:**

Each DTF-521 LCD panel is produced under very stringent quality standards. Production techniques cannot guarantee an absolutely perfect TFT display, and some panels may exhibit a certain number of pixels that show an incorrect color. See the specifications on page 49 for more information.

If an image has fine striping (such as screen stripes), it may appear to flicker or display a moiré pattern.

Do not apply excessive pressure on the display surface, it may cause the appearance of a moiré or pooling pattern. If this occurs, use less pressure on the display screen when working with the pen.

When a still image is displayed for a long period of time, an after-image may remain for a short time. To prevent this, Wacom recommends using a screen saver or other power management feature.

**Important:** To extend the life of the backlight, set your computer's power management to turn off the display when it is not in use for extended periods of time.

## STEP 2: PEN TABLET INSTALLATION

### USB CABLE INSTALLATION

Plug the square end of the USB cable into the DTF-521 port labeled USB. Plug the other end into an available USB port on your computer or on a USB hub attached to your computer. See **- D -** in the diagram below.

### PEN TABLET CABLING DIAGRAM

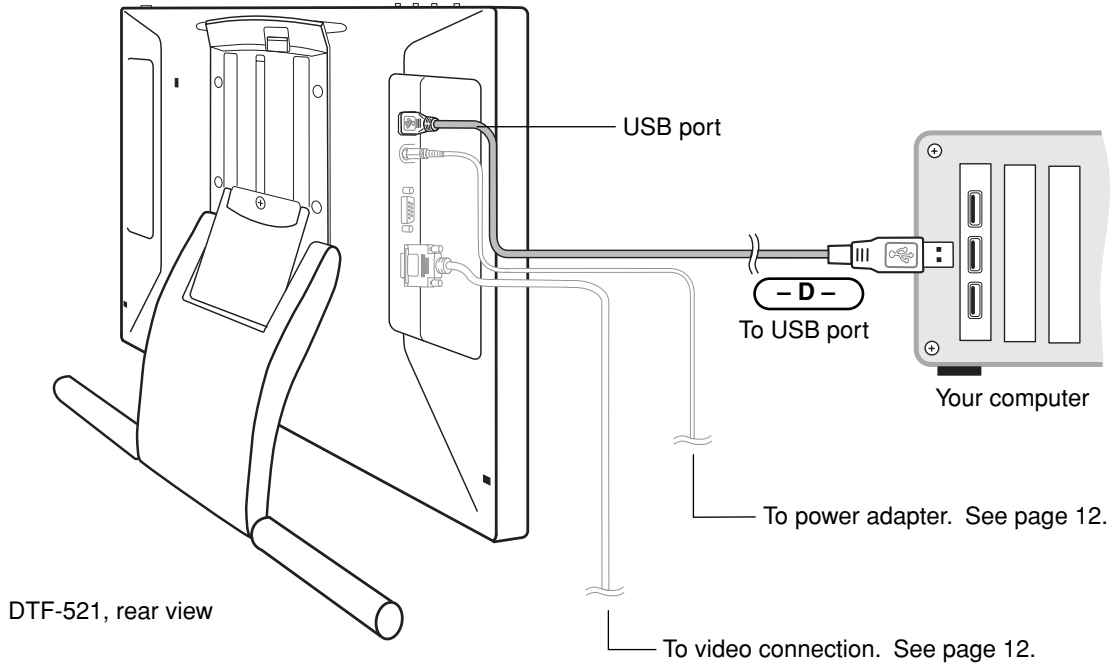



## SOFTWARE INSTALLATION

**IMPORTANT:** You MUST install the Wacom pen tablet driver software for correct pen-on-screen functionality.

To install the tablet software:

- Save your work and close all open applications. Temporarily disable any virus protection programs.
- Insert the Wacom Pen Tablet Driver CD into your computer's CD-ROM drive. If the software installer menu does not automatically display, double-click on the INSTALL icon located on the CD.
- Click on the INSTALL TABLET link and follow the prompts to install the driver software.
- Reactivate your virus protection program.
- After the software installation has been completed, make sure you can use your pen on the DTF-521 display to move the screen cursor.

When you place the pen tip on the display screen, the screen cursor should immediately jump to a corresponding position approximately beneath the pen tip. Lift the pen tip and place it on the display screen surface in a different location – the screen cursor should again jump to the new position. This is known as absolute positioning, and enables you to position the screen cursor without having to drag your pen across the display screen surface.

- Be sure to check the Read Me file for updated information. If you have trouble installing the DTF-521, see the *Troubleshooting* section beginning on page 32.

**Notes:**

For Windows Vista, driver installation automatically activates the new pen input functions available within Windows Vista and Office 2007 (except for Windows Vista Home Basic).

For Windows Vista, XP, and Macintosh OS X, user-specific preferences are supported. After logging in, each user can customize their personal settings in the Pen Tablet control panel. Switching to another user will automatically load the settings for that user.

To uninstall the tablet driver, see *Uninstalling the DTF-521* on page 48.

Next, adjust the pen display tablet calibration to precisely align the screen cursor to the pen tip. See *Calibrating the DTF-521* on page 22.

# WORKING WITH YOUR DTF-521

As you work with the DTF-521 interactive pen display you can rest your hand lightly on the display screen, just as if it were a drawing board or sheet of paper.

Because the DTF-521 surface will be a little higher than your desk, consider adjusting the height of your desk or chair to assure comfortable use of the device.

## **SETTING UP YOUR WORK AREA**

To minimize fatigue, organize your work area so you can work comfortably. Position the DTF-521, the pen, and your keyboard so they are easily accessible without unnecessary reaching. The pen display and any other displays should be positioned so you can view them comfortably with a minimum of eyestrain.

Here are some other points to keep in mind:

- Take short breaks between tasks to stretch and relax your muscles.
- Use a gentle grip when working with the pen.
- Alternate tasks throughout the day.
- Maintain a good posture at all times. Minimize awkward postures and repetitive movements that cause discomfort. Change your position if you feel any discomfort due to your work position.
- Alternate between different modes of use.

**Note:** Wacom makes no representation, promise or guarantee that Wacom products will cure or prevent, in whole or in part, mouse-induced repetitive stress symptoms, injuries or conditions. Individual results may vary. Always obtain competent medical advice to determine the most appropriate treatment for your specific situation.

### **Tips:**

- Be careful that you do not pull the cables out of their connections by accidentally moving the DTF-521 too far from the computer.
- The pen tether can be used to ensure your pen stays with your pen display. Simply loop one end of the tether through the tether hole located on the pen, and the other end of the tether through the tether connection ring. Then use the small thumb screw to attach the tether ring to one of the four attachment points located on the back of the unit.
- The DTF-521 can also be mounted to articulated arms or other third-party stands meeting the VESA 75 specification for display stands. For details, see *Using an alternate mount or stand* on page 45.

## USING THE PEN

The Wacom pen is cordless, battery-free, and senses the amount of pressure you apply to the tip. Hold the pen like you would a normal pen or pencil. Make sure the programmable DuoSwitch is in a convenient location where you can toggle it with your thumb or forefinger, but not accidentally press it while writing or drawing. As you work, you can rest your hand lightly on the DTF-521 display screen, just as if it were a drawing board or sheet of paper. You can tilt the pen in any way that feels most comfortable for drawing.

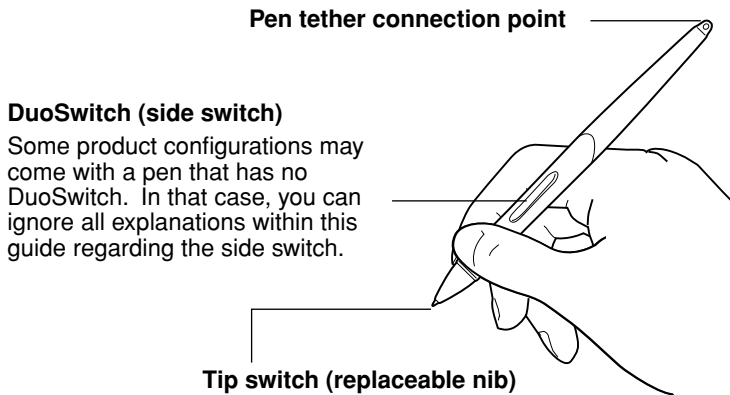

**Note:** When the pen is not in use, place it in the pen tray, the pen storage compartment, or lay it flat on your desk. To maintain the sensitivity of your pen, do not store the pen in a container where it will rest on its tip.

## PEN COMPONENTS

The components of your pen function in the following manner:

**Pen tip:** The pen is activated as soon as it is brought within 5 mm (0.2 inch) of the pen display screen. This allows you to position the screen cursor without touching the pen tip to the display screen. When pressure is applied to the pen tip, the tip switch is turned on and the pen simulates a primary mouse button click. The tip click pressure can be adjusted in the Pen Tablet control panel.

**DuoSwitch:** The DuoSwitch is programmable, and can be used to perform the same click and double-click functions as the tip switch. Toggle the DuoSwitch in either direction to activate the upper or lower button functions. You can use the DuoSwitch whenever the pen tip is within 5 mm (0.2 inch) of the display screen surface; you do not need to touch the pen tip to the display surface in order to use the switch. By default, the upper switch is set to DOUBLE CLICK and the lower switch is set to RIGHT CLICK.

**Important:** Use only the pen that came with your DTF-521 pen display. Other pens may not function properly. Also, the DTF-521 pen tip is specifically designed for use with the DTF-521 pen display – the tips on other pens could damage the protective coating on the DTF-521 display screen.

See *Customizing the pen* on page 20 for information on customizing the pen settings.

## PEN OPERATIONS

**Pointing and selecting:** Move the pen above the DTF-521 display screen to position the screen cursor. The pen tip needs to be within 5 mm (0.2 inch) of the display screen surface; you do not need to touch the display surface to move the screen cursor. The cursor jumps to the location where you place the pen (absolute positioning). Press the pen tip on the display screen to make a selection.

**Note:** You must calibrate the pen display tablet to correctly align the screen cursor with the pen tip. (See *Calibrating the DTF-521* on page 22.) If the screen cursor does not jump to a position close to the pen tip when you place the pen on the display screen, then the pen tablet driver may not be installed or is not loading. Install the pen tablet driver software if necessary. Otherwise, see *Troubleshooting*, beginning on page 32.

**Clicking:** Tap the display screen once with the pen tip, or touch the pen to the display screen with enough pressure to register a click.

**Windows tip:** You can make navigating with the pen easier by configuring Windows to select when the pen is over an icon and to launch the icon with a single click. To turn on this feature, first open a folder.

For Windows Vista, From the ORGANIZE pull-down menu choose FOLDER AND SEARCH OPTIONS. From the GENERAL tab select SINGLE-CLICK TO OPEN AN ITEM (POINT TO SELECT).

For other Windows versions, from the TOOLS pull-down menu choose FOLDER OPTIONS.... From the GENERAL tab select SINGLE-CLICK TO OPEN AN ITEM (POINT TO SELECT).

**Double-clicking:** Press the upper side switch, or quickly tap the display screen twice in the same place with the pen tip. Double-clicking is easier when the pen is perpendicular to the tablet screen. To fine-tune the double-click area, see *Adjusting double-click* on page 24.

**Dragging:** Select an object, then slide the pen tip across the display screen to move the object.

**Using the side switch:** The pen is equipped with a DuoSwitch. This switch has two programmable functions that can be selected by rocking the switch in either direction. You can use the DuoSwitch whenever the pen tip is within 5 mm (0.2 inch) of the display screen surface; you do not need to touch the pen tip to the display surface in order to use the switch. The upper switch is set to DOUBLE CLICK, and the lower switch is set to RIGHT CLICK by default.

**Drawing and writing with pressure sensitivity:** The pen responds to the nuance and inflection of your hand movements, enabling you to create natural-looking pen and brush strokes within applications that support this feature. To draw and write with pressure, select a pressure-sensitive tool from your application's tool palette. As you work on the screen surface, use various amounts of downward pressure on the tip of the pen. Press lightly for thin lines or softer color. Press harder for thick lines or dense color.

# CUSTOMIZING

After you master the basics of using your pen on the DTF-521 interactive pen display, you may want to customize the way the pen works. The Pen Tablet control panel makes it easy to customize the DTF-521 and pen.

## **OPENING THE CONTROL PANEL**

To open the control panel, use the DTF-521 pen on the pen display:

**Windows.** Click on the Windows START button and choose ALL PROGRAMS. (For Windows 2000, choose the PROGRAMS group.) Then select TABLET and choose the PEN TABLET PROPERTIES option.

**Macintosh.** Open SYSTEM PREFERENCES from either the Dock, the Apple menu, or from the APPLICATIONS folder. Then click on the PEN TABLET icon.

After opening the control panel, see *Control panel overview* on page 20.

### **Notes:**

For Windows Vista, XP, and Macintosh OS X, user-specific preferences are supported. After logging in, each user can customize their personal settings in the Pen Tablet control panel. Switching to another user will automatically load the settings for that user.

When more than one Wacom tablet is installed on a single computer, any changes made in the Pen Tablet control panel will be applied only to the tablet that was last used before opening the control panel.

# CONTROL PANEL OVERVIEW

Use the Pen Tablet control panel to customize your product. Experiment with different settings to find what works best for you. Any changes you make will take effect immediately, but you can always click DEFAULT to return to the factory settings.

Tool tips are available for most control panel items. Position the screen cursor over an item and let it rest there; in a few moments the Tool Tip will pop up.

Additionally, your keyboard tab and arrow keys can be used to navigate the control panel.

## CUSTOMIZING THE PEN

Selects the pen side switch button functions. See page 24.

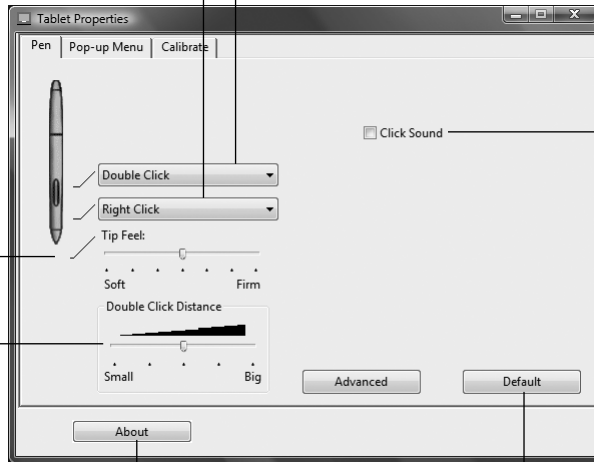

Customizes the amount of pressure needed to click or draw with the pen.

Adjusts the size of the double-click area. See page 24.

Displays information about the control panel and driver.

Returns the PEN tab settings to their factory defaults.

Closes the control panel.

When checked, an audible "click" sound will be heard whenever a pen click occurs and your computer speakers are turned on.

**Hint:** To create broad brush strokes or to click with a light touch, use a soft tip setting. A soft setting provides a wider range of pressure values with most pressure-sensitive applications. In some applications, a soft pressure setting can make the pen overreact – any small press on the pen is magnified on the screen. If you experience this, try a firmer tip setting. A firm tip setting will give you maximum control while drawing thin lines.

**Note:** When customizing your pen, choose those options that match the buttons on the pen with which you are working.

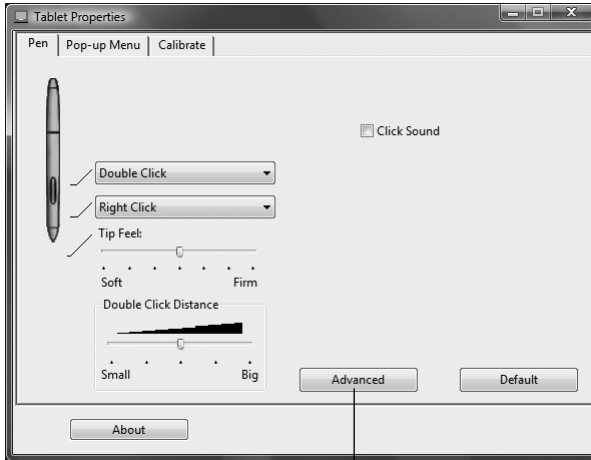

You can change the SIDE SWITCH MODE for the way you like to use the pen when making right-clicks or other click functions. Click on the ADVANCED button. In the dialog box that appears:

- Select HOVER CLICK to perform click functions without touching the pen tip to the tablet surface.
- When CLICK & TAP is selected, you must first press the pen button and then touch the pen tip to the tablet surface in order to perform a click function. CLICK & TAP enables the precise placement of your click functions.

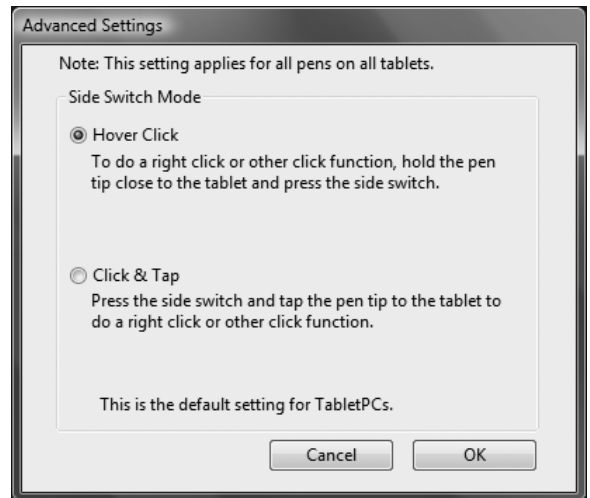

# CALIBRATING THE DTF-521

You must calibrate the pen display tablet in order to align the screen cursor position with the position of the pen on the display screen. This is required to adjust for parallax caused by the display screen cover glass and coating. Set the DTF-521 in its working position, then follow the procedure below.

**Important:** Make sure the display is properly adjusted before calibrating the tablet. See *Adjusting pitch and phase* on page 30, and *Adjusting the display* beginning on page 27.

- In the Pen Tablet control panel, select the CALIBRATE tab.
- If you are working with multiple monitors, select the MONITOR corresponding to the DTF-521 display. (Only monitors that are set to one of the resolutions supported by the DTF-521 will appear in the list.)
- Click on the CALIBRATE... button to activate the calibration screen.
- Hold the pen and position your head as you normally do when working with the pen display. Use the pen tip to click on the center of the crosshairs in the upper-left corner.
- Then click on the center of the crosshairs that are displayed in the lower-right corner.
- Test the alignment by positioning the pen at a few different points on the display. Click OK to accept the calibration. Click TRY AGAIN to recalibrate.

Be sure to read the directions in the calibration screen for detailed instructions and additional options. The calibration setting applies to all applications.

Adjustment pattern for pitch and phase. See *Adjusting pitch and phase* on page 30 for details.

### Notes:

If you prefer to see the screen cursor slightly offset from the actual position of the pen tip, calibrate by clicking on a spot showing that offset from the crosshairs. For example, to have the screen cursor appear 1/10th of an inch above and to the left of the pen tip, calibrate by clicking on a spot 1/10th of an inch below and to the right of the crosshairs.

To calibrate two pen displays, first touch the pen to pen display #1 and open the control panel without touching the pen to pen display #2. In the control panel, select the correct monitor and calibrate pen display #1. Close the control panel, touch the pen to pen display #2, and again open the control panel without touching the pen to pen display #1. Select the correct monitor and calibrate pen display #2.

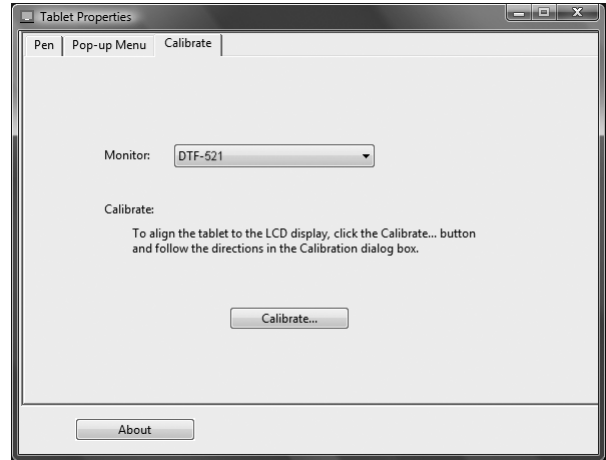

### Crosshairs





## CUSTOMIZING THE POP-UP MENU

Use the POP-UP MENU tab to define the available functions on the Pop-up Menu list.

To display the Pop-up Menu, set a pen button to the POP-UP MENU function. Whenever you press that button, the Pop-up Menu is displayed. Select from available items in the Pop-up Menu by clicking on them. To close the Pop-up Menu without making a selection, click outside of the Pop-up Menu.

Select a button function to add to the Pop-up Menu list. See page 24.

Displays a list of functions that have been added to the Pop-up Menu.

To change the order of an item, drag it to a new location. Double-click on an item to make edits.

Removes the selected item from the list.



Sets the FONT and FONT SIZE of the Pop-up Menu.

Returns all tab settings to their default values.

**Important:** This action will delete all Pop-up Menu items that have been defined.

# CONTROL PANEL DETAILS

## ADJUSTING DOUBLE-CLICK

Double-clicking with the pen tip can be made easier by expanding the tap area that accepts a double-click (the double-click distance), or by using the pen's side switch to automatically double-click when pressed. A large double-click distance may cause a delay at the beginning of your brushstrokes in some drawing applications. If you notice such effects, try setting a smaller double-click distance and using the side switch to double-click.

**Hint:** Press the upper switch to double-click. This is easier than tapping twice with the pen tip.

## CUSTOMIZING THE SIDE SWITCH BUTTON FUNCTIONS

You can set the pen's DuoSwitch to simulate a variety of functions. Just select an option from the pull-down menu for either the upper or lower side switch. Your changes take effect immediately. When you bring the pen tip within 5 mm (0.2 inch) of the pen display tablet surface without touching the tablet and press the side switch, the selected function occurs. The following list describes the available options.

**CLICK.** Default setting for the pen tip. Simulates a primary mouse button click.

**DOUBLE CLICK.** Default setting for the upper position of the side switch. Simulates a double-click. For easier double-clicking, use this function instead of tapping twice with your pen tip.

**MIDDLE CLICK.** Simulates a middle mouse button click.

**RIGHT CLICK.** Default setting for the lower position of the side switch. Simulates a right mouse button click, which displays a context menu.

**CLICK LOCK.** Simulates holding down the primary mouse button. Press the side switch once to initiate click lock. Press the switch again to release click lock. Click lock is useful for dragging objects or selecting blocks of text.

**4TH CLICK (BACK).** Simulates a 4th mouse button click, which on Windows systems typically issues the BACK command in browser applications.

**5TH CLICK (FORWARD).** Simulates a 5th mouse button click, which typically issues the FORWARD command in browser applications.

**PAN/SCROLL.** Enables you to position a document or image in any direction within the active pane by pressing a pen switch set for PAN/SCROLL and then sliding the pen tip across the DTF-521 display screen.

When you select PAN/SCROLL, you are prompted to set a scrolling speed that will be used in applications that do not support grabber hand (pixel-level) panning within a document or image.

A slower setting reduces the scroll rate and is useful for close-up and detail work where you need precise control of the image.

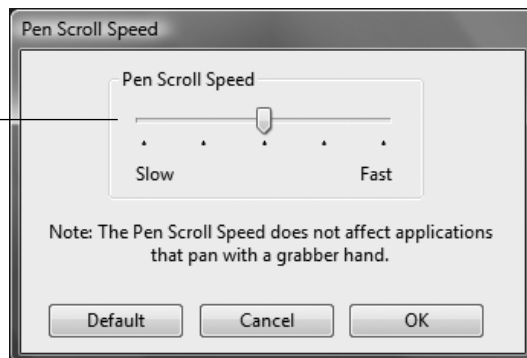

**TABLET PC INPUT PANEL.** (Tablet PCs and Windows Vista systems that support the Tablet PC Input Panel.) Opens the Tablet PC Input Panel when you press a tool button set to this function.

**JOURNAL.** (Windows Vista and Tablet PC systems that include Microsoft Journal.) Opens Microsoft Journal.

**POP-UP MENU.** Displays a Pop-up Menu on your screen. See *Customizing the Pop-up Menu* on page 23 for more information.

**ERASE.** Sets a button so that when the button is pressed, the pen tip will act like an eraser in applications that support the ERASE function.

**INK TOGGLE.** (Macintosh.) Toggles the Ink ANYWHERE function of Inkwell on and off. Inkwell automatically recognizes and converts your handwriting into text and inserts it into a document. Note that Ink must be turned on for this button function to work. See your Macintosh help for information on working with Inkwell.

**MODE TOGGLE....** Toggles between the pen tracking mode (pen mode) and mouse mode. The tracking mode you select determines the relationship between pen movement and cursor movement.

The Mouse Mode Details dialog box will appear when you first set a tool button to MODE TOGGLE....

- With the pen display tablet correctly calibrated in pen mode, the screen cursor should always follow the physical pen tip on the screen. This is the default setting.
- When toggled to your computer's mouse settings (mouse mode), the screen cursor is not directly "linked" to the pen tip and is positioned like a mouse, requiring a "pick up and slide" motion to move the cursor on the screen. On multiple display systems, mouse mode will allow you to access the other display(s) with your pen.

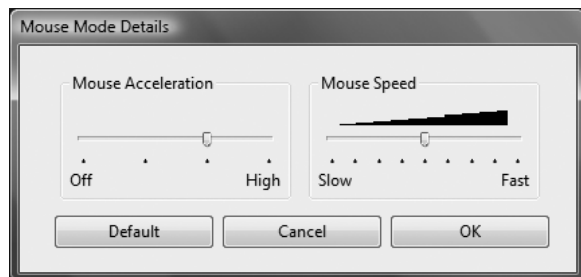

**MODIFIER....** Enables you to assign modifier key(s) (such as SHIFT, ALT, or CTRL for Windows, or SHIFT, OPTION, COMMAND, and CONTROL for Macintosh). Many applications use modifier keys to constrain the size or placement of objects.

In addition to choosing one or more modifier key options, you can select the CLICK box if you want a mouse click to occur whenever you press the tool button.

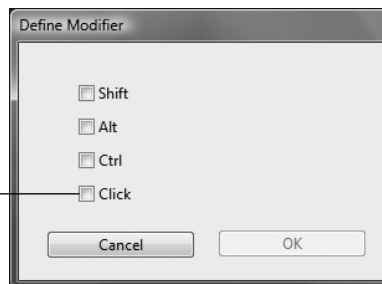

**KEYSTROKE....** Enables you to simulate keystrokes. Selecting this option displays the DEFINE KEYSTROKE dialog box where you can enter a keystroke or keystroke sequence to play back.

You can manually enter a keystroke or keystroke combination in the KEYS entry box. Keystroke combinations can include letters, numbers, function keys (such as F3) and modifier keys (such as SHIFT, ALT, or CTRL for Windows, or SHIFT, OPTION, COMMAND, and CONTROL for Macintosh).

You can also select special keystrokes or keystroke combinations from the ADD SPECIAL drop-down menu.

After defining a keystroke sequence, click OK.

**Important:** Because the ENTER (Windows) and RETURN (Macintosh) keys can be selected as a defined keystroke, they cannot be used to select OK. You must use your pen to click on the OK button.

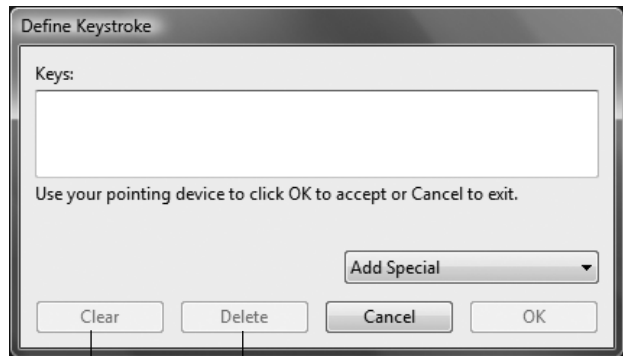

Clears the keystroke entry box.

Deletes only the last entry in the keystroke entry box.

If prompted, enter a name for the keystroke definition. The name will be displayed with the respective control or in the Pop-up Menu list, as applicable.

**OPEN/RUN....** Opens a dialog box where you can select a specific application, file, or script to launch.

Click BROWSE... to locate an application, file, or script to launch. The selection you make appears in the APPLICATION TO RUN box.

Click OK to accept the selection. The dialog box will close and the OPEN/RUN... option will be assigned as your pen button option. If your selection is for the Pop-up Menu, it will be displayed in the Pop-up Menu list.

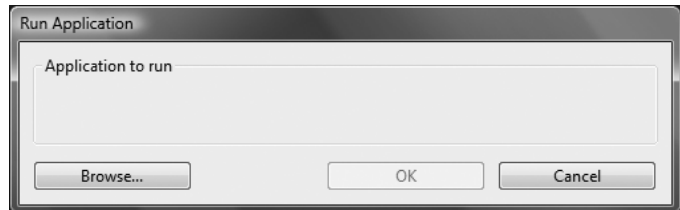

**PRESSURE HOLD.** Locks the pressure at the current pressure level until the side switch is released. For example, you can paint with pressure sensitivity until you reach the brush size that you like. You can then press the switch and continue painting with the same size brush until the switch is released.

**EXPOSÉ.** (Macintosh.) Tiles all open windows.

**DISABLED.** Disables the button function.

**DEFAULT.** Returns a button to its default setting.

# ADJUSTING THE DISPLAY

## FACTORY PRESETS, AUTO-SYNC, AND USER SETTINGS

**Factory presets:** For optimal display quality, set your video card to the DTF-521's native resolution of 1024 x 768 pixels. See page 49 for signal specifications.

**Auto-sync:** The DTF-521 attempts to automatically synchronize to the incoming signal. Auto-sync will function when the horizontal frequency is between 30 to 57 kHz and the vertical frequency is between 45 to 70 Hz for XGA mode, or 45 to 75 Hz for other modes. If the DTF-521 does not automatically synchronize with the incoming signal, you can use the On Screen Display (OSD) RESET AUTO ADJUST option to initiate display synchronization. Further screen display adjustments can be manually made using the OSD controls.

**User settings:** When you manually set the display using the OSD function, the settings are stored within the DTF-521 for use the next time the unit receives a similar signal. This is applicable to all display modes.

## ON SCREEN DISPLAY (OSD) SETTINGS

The OSD function enables you to adjust and optimize a variety of display settings at the touch of a button. The OSD controls are located on the upper left edge of the unit.

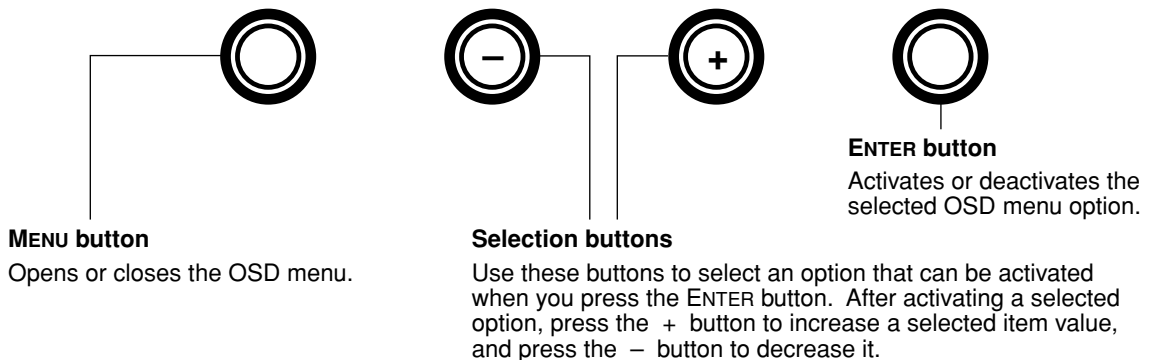

The basic process for working with the OSD is as follows:

- Press the MENU button to open the OSD main menu.
- Use the + or - buttons to select an option. When the option you want to adjust is highlighted, press the ENTER button. The current settings and adjustment sub-menu for that option will appear.
- Use the + or - buttons to adjust the option settings.
- After making your changes, press the ENTER button to save. To exit, press the MENU button.

**Note:** All settings are automatically saved when the OSD menu closes. If you make changes to the display appearance and cannot return to the original settings, use the RESET RECALL option to return the DTF-521 to its original factory defaults.

When you open the OSD menu, the following options are displayed:



**CONTRAST.** Select to increase or decrease image contrast.

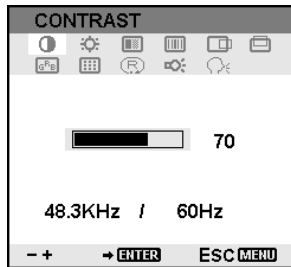

**BRIGHTNESS.** Select to increase or decrease image brightness.

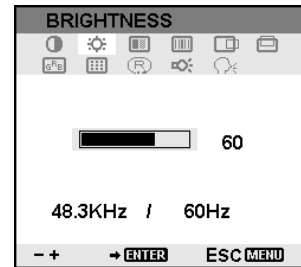

**PHASE.** Select to reduce or eliminate horizontal distortion lines.

To automatically adjust, use the RESET option.

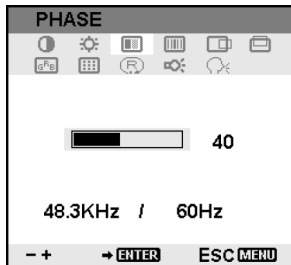

**PITCH.** Select to reduce or eliminate vertical distortion lines.

To automatically adjust, use the RESET option.

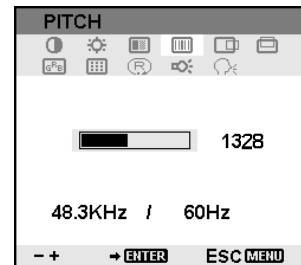

**HORIZONTAL CENTER.** Select to move the screen image left or right.

To automatically adjust, use the RESET option.

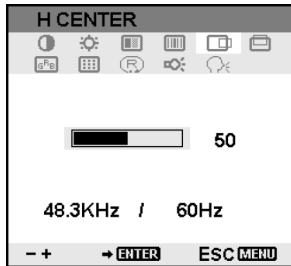

**VERTICAL CENTER.** Select to move the screen image up or down.

To automatically adjust, use the RESET option.

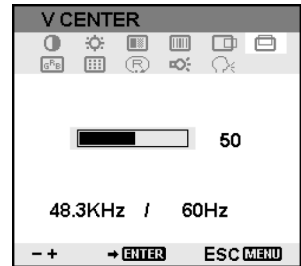

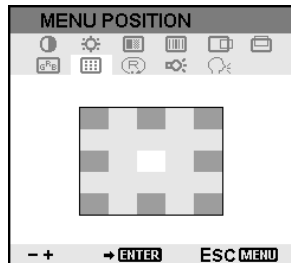

**MENU POSITION.** Select to move the OSD menu around the display screen.

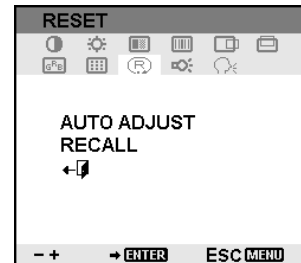

**RESET.** Provides two options: Use AUTO ADJUST to reset only the image parameters.

Use RECALL to reset all screen options to the factory default.



Selecting the EXIT  icon exits the RESET window without resetting anything.



**BACKLIGHT.** Select to increase or decrease the backlight brightness level.

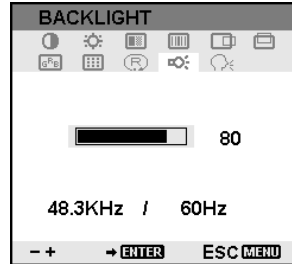

**LANGUAGE.** Select to choose a language option for the OSD.



**COLOR.** Provides color temperature settings for 9300°, 6500°, and 5000° Kelvin.

DIRECT displays the received signal as it is without any adjustment.

When DIRECT is selected, the BRIGHTNESS and CONTRAST settings are also set to DIRECT and cannot be adjusted manually.

The USER option enables you to adjust Red, Blue, and Green independently.

Choose a setting and press ENTER to activate your selection.

Change the USER setting by selecting the ENTER icon. ↵

In the user adjustment COLOR window, change Red, Green, or Blue to calibrate color.

Select the EXIT ↵ icon to exit.

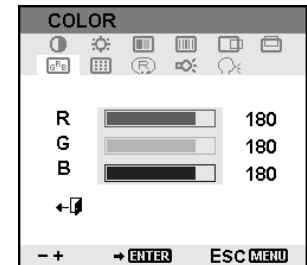
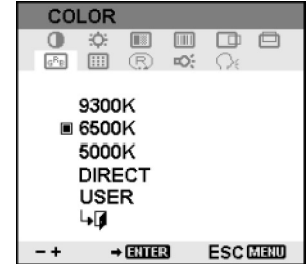

## ADJUSTING PITCH AND PHASE

Some computers and video cards may not allow the auto-sync function to fully work when the DTF-521 is first connected. If some portion of text appears blurred, adjust pitch and phase by following the procedure below. For crisp images, set the resolution of your video card to 1024 x 768.

- In the Pen Tablet control panel, select the CALIBRATE tab.
  - If you are working with multiple displays, be sure the display corresponding to the DTF-521 is selected in the MONITOR menu.
  - Click on the CALIBRATE... button to activate the calibration screen.
  - Using the OSD controls, open the OSD menu and select the PITCH icon. Then adjust the pitch level so that the pattern of fine vertical stripes displays evenly. (For details on changing the OSD settings, see *On Screen Display (OSD) settings* on page 27.)
  - In the OSD menu, select the PHASE icon. Adjust the phase level so that the adjustment pattern shows clearly.
  - After completing these adjustments, press the ENTER and MENU buttons to exit the OSD menu.
- Click on the CANCEL button or press ESC to exit the calibration screen.

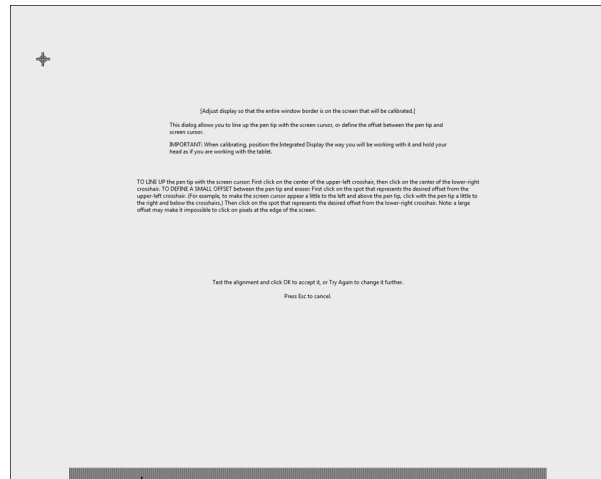
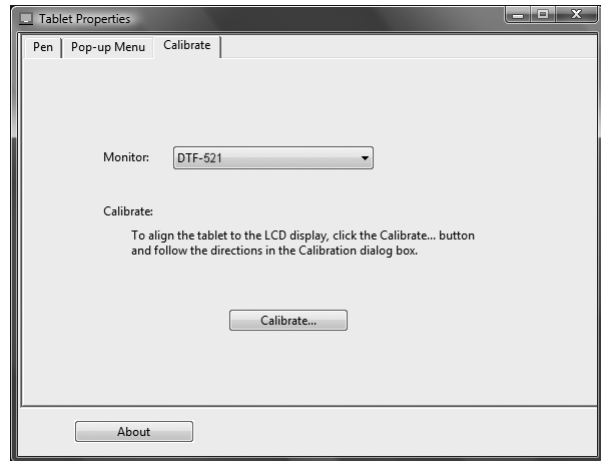

Adjustment pattern for pitch and phase.



## POWER SAVING

The DTF-521 conforms to VESA and ENERGY STAR® power saving guidelines.

When using the DTF-521 with a Display Power Management Signaling (DPMS) compliant computer or video card, the display will automatically comply with the below power saving parameters. When these power-saving functions are in effect, the screen display is darker than usual.

<b>Computer mode</b>	<b>H-sync</b>	<b>V-sync</b>	<b>Video</b>	<b>Power consumption</b>	<b>Power lamp</b>
Power ON	Yes	Yes	Active	23W, max.	Blue
Standby mode	No	Yes	Blanked	2 W, max.	Blue/Orange*
Suspend mode	Yes	No	Blanked	2 W, max.	Blue/Orange*
OFF mode	No	No	Blanked	1 W, max.	Orange

\* Depending on the specifications and settings of your computer and video card, the power light may only change to orange when in standby and suspend modes.

# TROUBLESHOOTING

Most of the time your pen display tablet will work flawlessly. But if you are having trouble, Wacom recommends you do the following:

1. If the Wacom tablet driver failed to load properly, first perform the recommended action in any error message that may appear on your screen. If that does not solve the problem, continue with the troubleshooting procedures in this chapter.
2. If the DTF-521 does not function properly, refer to the troubleshooting section below. See also *Display troubleshooting* on page 34, or look in the *Pen tablet troubleshooting* on page 36. Your problem may be described there and you can try the solution offered.
3. Open the Wacom pen display Read Me file for updated information.
4. If you are having a compatibility conflict between the DTF-521 and a new hardware or software product, see *Obtaining driver downloads* on page 42 for information on downloading an updated software driver. Wacom periodically updates the software driver to maintain compatibility with new products.
5. Check the FAQs (Frequently Asked Questions) on the Wacom web site for your region.
6. If you have tried the suggestions in this guide and still cannot resolve the problem, then contact Wacom for Technical Support. See the Read Me file for information on where to obtain support for your region.

## TESTING THE DTF-521

### 1. If the DTF-521 power LED does not light, check the following:

- First verify that the green light on the power adapter is on. If the light is not on, check that the power cable is properly connected to the power adapter and to an active AC outlet.
- Check that the power adapter cable is securely connected to the DTF-521 and that the DTF-521 power switch is turned on. The DTF-521 power LED will glow orange or blue whenever the DTF-521 is on.

**Important:** Use only the AC adapter that came with your pen display. Other adapters may cause damage to your product.

### 2. If there is no display:

- Make sure that your computer is turned on. The power LED will light blue when the proper video signal is received, and orange if there is no video signal or if the computer is in a power saving mode.
- Verify that the DTF-521 is connected to an active VGA connector.
- Check that your video card has been properly installed and is functional. If you have another display that is compatible with your video card, you can connect that display to the card in order to verify that the video card is operating correctly.

### 3. Verify that the tablet and pen are working:

- Press the pen tip against the display and verify that the status LED lights blue.
- If the LED does not light, verify that the DTF-521's USB cable is plugged into an active USB port. If the DTF-521 is plugged into a USB hub, try plugging it directly into the USB port on your computer.
- Be sure that the USB port to which you are connecting has not been disabled. It may be necessary to check your system BIOS setting to verify that you have connected the DTF-521 to an active USB port.
- The status LED will light blue when the DTF-521 is registered as a USB device and the pen tip is pressed against the display.

### 4. Check the pen. If you cannot make a selection on the display screen with the pen:

- Test the pen by pressing the pen tip against the surface of the pen display tablet. The tablet status LED should light blue.
- Now, without applying pressure to the pen tip but keeping the pen within 5 mm (0.2 inch) of the pen display tablet surface, press the side switch. The status LED should again light blue.
- If the status LED does not light blue for these tests, be sure you are using the correct pen that came with your DTF-521.

If you are still having problems, you may have a defective pen or pen display.

# DISPLAY TROUBLESHOOTING

If you encounter problems with the DTF-521 display, refer to the following tables; your problem may be described here and you can try the solution offered. For additional information about color issues, refer to the documentation that came with your operating system or applications.

## GENERAL DISPLAY PROBLEMS

No display. The power LED is off.

- Verify that the AC power cable is connected, and that the DTF-521 power switch is turned on.

No display. The power LED is lit blue.

- Check the contrast, brightness, and backlight controls. Adjust as necessary, or open the OSD menu, go to the RESET menu and select the RECALL option.

The power LED is lit orange.  
The following message appears briefly on your display screen:

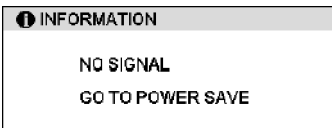

- Your computer may be in a power management mode. Touch the pen tip to the display screen, move the mouse, or depress any key on your keyboard.
- Verify that the video card is properly installed.
- Turn off both your computer and the DTF-521 pen display tablet, and check the video cable for bent or broken connector pins. Then properly connect the video cable and turn on the DTF-521 and your computer.

The following message appears briefly on your display screen:

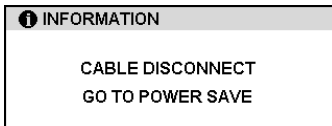

- Check that your computer is turned on.
- Verify that you are using the video cable that came with the DTF-521.
- Check that the DTF-521 video cable is fully connected.
- Turn off both your computer and the DTF-521 pen display, and check the video cable and any video adapters for bent or broken connector pins. Then properly connect the video cable and any necessary adapters.

The following message appears briefly on your display screen:

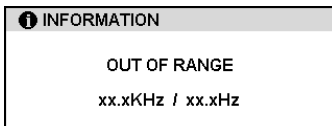

- The input signal frequency is incorrectly set or not compatible with the DTF-521. For XGA, set the refresh rate (vertical frequency) between 45 and 70 Hz. For other modes, set the frequency to some value between 45 and 75 Hz. If your video card driver supports adjustment of the horizontal frequency, make sure it is set to some value between 30 and 57 kHz. On a single monitor system you will need to connect a different display to change the refresh rate.
- The resolution is set too high (1024 x 768, maximum).
- The refresh rate is set too high (70 Hz maximum for XGA, and 75 Hz maximum for other modes).
- Set the display properties to detect plug and play monitors.

The following message appears briefly on your display screen:

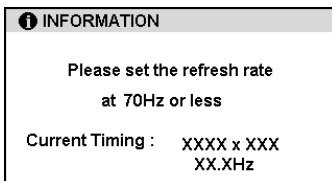

- The maximum refresh rate in XGA mode is 70 Hz. Set the refresh rate (vertical frequency) to some value between 45 and 70 Hz.

The image appears multiple times on the display.	<ul style="list-style-type: none"> <li>Do not extend the video cable. Do not use an input selector switch box.</li> </ul>
When a still image is displayed for a long period of time without refreshing the screen, an after-image remains for a short period of time.	<ul style="list-style-type: none"> <li>Use a screen saver or other power management feature.</li> </ul>
Color quality is inaccurate.	<ul style="list-style-type: none"> <li>Open the OSD menu, go to the RESET menu and select the RECALL option.</li> <li>Any changes to the contrast setting should be made in small increments as changes in contrast may affect color accuracy.</li> </ul>
The color white does not display as white.	<ul style="list-style-type: none"> <li>Verify that the display is operating at the factory default settings. If that is not sufficient, then adjust color as necessary. For details on color management, refer to your operating system and application documentation.</li> <li>Verify that the video cable and connector are fully connected.</li> </ul>

## VGA PROBLEMS

The display ripples or flickers.	<ul style="list-style-type: none"> <li>Open the OSD menu, go to the RESET menu, and select the AUTO ADJUST option. Then, if necessary, manually adjust pitch and phase.</li> <li>Verify that the display adapter or video card matches the specifications for the DTF-521.</li> <li>Adjust the refresh rate in the Display Properties control panel.</li> </ul>
The display is not clear. Text or other portions of the screen appear blurred.	<ul style="list-style-type: none"> <li>Set the display resolution of your video card to 1024 x 768.</li> <li>Turn off the DTF-521, then turn it back on.</li> <li>Open the OSD menu, go to the RESET menu, and select the AUTO ADJUST option. If necessary, manually adjust the brightness, pitch, and phase settings.</li> </ul>
The display and LCD panel are not lined up. The display size is not correct.	<ul style="list-style-type: none"> <li>Open the OSD menu, go to the RESET menu, and select the AUTO ADJUST option.</li> <li>As necessary, adjust pitch and phase, and horizontal and vertical position. Note that some video cards may not show the display in proper sizing.</li> </ul>
The display ripples or shows a moiré pattern. The display color is not even.	<ul style="list-style-type: none"> <li>Open the OSD menu, go to the RESET menu, and select the AUTO ADJUST option. If this does not solve the problem, go to the RESET menu and select the RECALL option to set the display back to the factory default settings.</li> <li>As necessary, adjust pitch and phase.</li> </ul>

## PEN TABLET TROUBLESHOOTING

If you encounter problems with the DTF-521 pen display, refer to the following tables. Your problem may be described here, and you can try the solution offered. Be sure you refer to the DTF-521 Read Me file for the latest information.

For additional information, visit Wacom's web site at <http://www.wacom.com/productsupport> and follow the links to the FAQs.

### GENERAL PROBLEMS

The computer does not have an available USB port.	Check if there is an available USB port on a USB hub. If not available, you will need to add a USB hub or USB card.
A USB device plugged into one of the pen display's integrated USB ports does not function.	<ol style="list-style-type: none"><li>1. Make sure the pen display itself is properly connected to a working USB port on your computer.</li><li>2. Then be sure the pen display is powered on and that the power LED lights blue. The DTF-521 contains a powered USB hub and the integrated USB ports will not work when the power is off.</li><li>3. If the USB device does not work, try plugging it into a USB port directly on your computer.</li><li>4. If your USB device is still not functioning properly, please contact the manufacturer for that particular device.</li></ol>
The pen display power LED is off.	<p>Make sure the pen display power switch is turned on.</p> <p>Check that the AC power adapter is plugged into both the pen display and an active power outlet.</p> <p>Use only the power adapter that came with the pen display; other adapters may cause damage to your product.</p>
The pen works only in mouse mode, and does not draw or write with pressure sensitivity.	<p>The tablet driver software was not installed or did not load properly. Make sure the tablet driver software is installed and functioning. Install the pen tablet driver software in accordance with the instructions found in the <i>Installation</i> section of this guide.</p>
The pen does not draw or write with pressure sensitivity.	<p>Some applications require that you turn on the pressure capabilities within the application or selected tool before the pen will respond as a pressure-sensitive tool.</p> <p>Verify also that your application supports pressure sensitivity.</p>
Clicking is difficult.	<p>Open the Pen Tablet control panel and go to the Pen tab. Try using a lighter TIP FEEL.</p>
The pen selects everything or will not stop drawing.	<p>Open the Pen Tablet control panel and go to the PEN tab. Move the TIP FEEL slider toward FIRM. If this does not help, see <i>Testing the DTF-521</i> on page 32.</p>

Double-clicking is difficult.	<p>Be sure you are quickly tapping the display screen twice in the same place on the pen display tablet's active area. Wacom recommends using the side switch to double-click.</p> <p>Open the Pen Tablet control panel and go to the PEN tab. Try increasing the DOUBLE CLICK DISTANCE or using a lighter TIP FEEL.</p> <p><b>Windows:</b> Try setting your system to launch programs with a single click. See <i>Pen operations</i> on page 18.</p>
You notice a delay at the beginning of pen strokes.	<p>Open the Pen Tablet control panel and go to the PEN tab. Try decreasing the DOUBLE CLICK DISTANCE.</p>
You have to press hard with the pen when clicking, drawing, or writing.	<p>Open the Pen Tablet control panel and go to the PEN tab. Move the TIP FEEL slider toward SOFT.</p>
The pen tip does not function.	<p>Be sure you are using the pen that originally came with your pen display. Other pens may not function properly on the DTF-521 pen display.</p> <p>Make sure the status LED lights blue when the tip is pressed. If the LED does not light, verify that the USB cable is plugged into an active port on your computer or on a USB hub.</p> <p>If the LED still does not light, you may have defective hardware (see <i>Troubleshooting</i> on page 32).</p>
The side switch does not work.	<p>Be sure you are using the pen that originally came with your pen display. Other pens may not function properly on the DTF-521 pen display.</p> <p>Be sure you press the side switch when the pen tip is within 5 mm (0.2 inch) of the pen display's active area – do this without pressing down on the pen tip.</p> <p>From the Pen Tablet control panel, verify that the side switch is set to the proper function you are expecting to occur.</p> <p>Make sure the status LED lights blue when you press the side switch. If the LED does not light, verify that the USB cable is plugged into an active USB port on your computer or on a USB hub; the LED will not light if the USB cable is not plugged into an active port.</p> <p>If the LED does not light, you may have defective hardware (see <i>Troubleshooting</i> on page 32).</p>

The pen tip and screen cursor do not properly line up.

Open the Pen Tablet control panel and select the CALIBRATE tab. Continue with *Calibrating the DTF-521* on page 22.

---

The screen cursor moves but it does not jump to the pen tip location when the pen is placed on the display screen, and it does not follow the pen tip when the pen is moved across the display.

Make sure the Wacom tablet driver has loaded properly by opening the Pen Tablet control panel. If the driver did not load you will see an error message. If an error message appears, reboot your computer. If the problem persists, refer to the *Installation* instructions and reinstall the Wacom tablet software. (For Macintosh, you must restart your computer after installing the Wacom tablet driver for proper tablet operation.)

If you have customized the side switch on your pen to toggle between pen mode and mouse mode, make sure that your pen display is operating in pen mode. See *Customizing the side switch button functions*, beginning on page 24.

---

When using the pen display tablet on a multiple monitor system, you cannot use the pen to control the other monitor(s).

You can use your pen to control the other monitors in mouse mode. To use mouse mode, first set the pen's DuoSwitch to MODE TOGGLE.... Then use the switch to toggle between pen mode and mouse mode.

---

The line you are drawing does not line up with the location of the screen cursor.

To function properly, some applications require that the pen is set to pen mode. Make sure the pen has not been toggled to mouse mode. If the pen is set to pen mode and the problem still exists, then you may have a corrupted preferences file. Follow the instructions in the next tip to create a new preferences file.



You suspect the pen tablet preferences may be corrupted, or want to make certain that all settings are at their factory defaults.

Delete the pen tablet preferences as follows:

**Windows:** Click the START icon and select ALL PROGRAMS. Then select TABLET and TABLET PREFERENCE FILE UTILITY. In the dialog box that appears, click on the REMOVE MY PREFERENCE FILE button to delete the preferences for the current user. To delete preferences for multiple users on Windows Vista or XP systems, click on the REMOVE ALL PREFERENCE FILES button. Note that administrator rights are required to delete preferences for all users. Relaunch any currently open tablet-aware applications that you may be running.

**Macintosh:** For a single user, delete the tablet preferences by first choosing your HOME folder from the GO menu. Then open your home LIBRARY folder. Within your home LIBRARY folder, open the PREFERENCES folder and delete the COM.WACOM.WACOMTABLET.PREFS file. Log out, then log back in. When the tablet driver loads it will create a new preferences file with the factory defaults.

For multiple users, delete all tablet preferences by first opening the main APPLICATIONS folder. Then open the WACOM TABLET folder and run the REMOVE WACOM TABLET utility. When the utility starts, click on the REMOVE ALL PREFERENCE FILES button. The tablet driver will be restarted, creating new preferences files with the factory defaults.

Recalibrate the tablet.

**Note:** Do not manually remove the WACOM TABLET.PREFPANE file from the main LIBRARY PREFERENCEPANES folder. This file is only to be removed when uninstalling the tablet software driver, and then only when using the REMOVE WACOM TABLET utility.

---

The computer does not go to sleep.

When you are not using the pen, remove it from the pen display surface or the pen display will continue to send data, keeping the computer awake.

---

The screen cursor jumps back when using your regular mouse or trackball.

When the pen is not in use, place it in the pen tray, the pen storage compartment, or at some location near the pen display, but not on the display. Leaving your pen on the display may interfere with screen cursor positioning when using other input devices.

---

The screen cursor moves erratically or jumps around on the display screen when another tablet is connected to your computer.

The tablet portion of the DTF-521 emits electromagnetic waves at a certain frequency. If another tablet is too closely placed to the DTF-521 it may interfere with screen cursor positioning. If this occurs, move the tablet further away from the DTF-521.

## WINDOWS-SPECIFIC PROBLEMS

After changing right- and left-handed settings in the computer's mouse control panel, the pen tip no longer functions properly.

Restart Windows for your Wacom tool settings to be correctly recognized.

## MACINTOSH-SPECIFIC PROBLEMS

At startup, a dialog box appears telling you that either the driver failed to load or the tablet preferences have not yet been created.

The pen display was not detected at startup. Make sure the USB interface cable is securely connected to an active USB port on your computer or to a USB hub. Make sure that the pen display power LED is on. If this does not correct the problem, see *Troubleshooting* on page 32.

From the GO menu, select the UTILITIES folder and launch the SYSTEM PROFILER. Select USB from the HARDWARE section of the CONTENTS list. A Wacom USB pen display model should be listed. If a pen display model is not listed, check the pen display's USB cable connection or try plugging the pen display into a different USB port.

If this does not help, contact Wacom for Technical Support. See *Technical support options* on page 41.

---

Inkwell does not work correctly with the pen display.

There may be a problem with the Inkwell preferences. Remove the damaged preference files as follows. They will be recreated when you enable handwriting recognition.

1. From the Apple menu, choose SYSTEM PREFERENCES. From the System Preferences menu, choose SHOW ALL and select INK. Then turn off handwriting recognition.
2. From the GO menu, choose your HOME. Open the LIBRARY and PREFERENCES folders. Then remove the following preferences:
  - com.apple.ink.framework.plist
  - com.apple.ink.inkpad.plist
  - com.apple.ink.inkpad.sketch
3. Go back to SYSTEM PREFERENCES and INK, and then enable handwriting recognition.
4. Test the Inkwell function using your Wacom pen display tablet and pen.
5. If this procedure does not resolve your problem with Inkwell, contact Apple Support for further assistance. Wacom is not the software manufacturer for Inkwell and we are limited in our abilities to support a third party software application.

## TECHNICAL SUPPORT OPTIONS

If you have a problem with your DTF-521 interactive pen display, first check the appropriate *Installation* section in this guide to make sure the unit is installed correctly. Then review the *Troubleshooting* procedures.

If you cannot find the answer in this guide, you may find updated information about your problem in the appropriate Read Me file for your platform (located on the Wacom Pen Tablet Driver CD). You can also check the product FAQs (Frequently Asked Questions) on the Wacom web site for your region.

If you have an Internet connection you can download the latest software drivers from the Wacom web site for your region. See *Obtaining driver downloads* on page 42.

If you cannot solve the problem and you think your Wacom product is not working properly, contact the Wacom support staff for the area where your product was purchased. See the Wacom tablet Read Me file, located on the Wacom Pen Tablet Driver CD, for contact information.

When you call, you should be at your computer with the following information available:

- This manual.
- Pen display serial number. (Look at the label on the back of the unit.)
- Driver version number. (See the Wacom Pen Tablet Driver CD or the Pen Tablet control panel.)
- The make and model of your computer, and operating system version number.
- The make, model, and connection type of your video card.
- A list of peripheral devices attached to your computer.
- The software application and version you were using when the problem occurred.
- The exact wording of any error message that appeared on your screen.
- What happened and what you were doing when the problem occurred.
- How you tried to solve the problem.

## OBTAINING DRIVER DOWNLOADS

Wacom periodically updates the pen tablet software driver to maintain compatibility with new products. If you are having a compatibility problem between your DTF-521 pen display and a new hardware or software product, it may be helpful to download a new Wacom tablet software driver (when available) from the Internet.

### USA, Canada, Central and South America

Worldwide Web: <http://www.wacom.com/productsupport> Driver downloads.

### Europe, Middle East and Africa

Worldwide Web: <http://www.wacom.eu> Software updates.

---

Anonymous FTP Site: <ftp://ftp.wacom.eu/pub/> Software updates.

### Japan

Worldwide Web: <http://tablet.wacom.co.jp> Software updates. (Japanese)

### Asia Pacific (English)

Worldwide Web: <http://www.wacom-asia.com> Software updates. (English)

### China

Worldwide Web: <http://www.wacom.com.cn> Software updates.  
(Simplified Chinese)

### Korea

Worldwide Web: <http://www.wacomdigital.co.kr> Software updates. (Korean)

### Taiwan

Worldwide Web: <http://www.wacom.com.tw> Software updates.  
(Traditional Chinese)

# APPENDIX

## **CARING FOR THE DTF-521**

Keep the pen and the DTF-521 LCD screen surface clean. Dust and dirt particles can stick to the pen and cause excessive wear to the display screen surface. Regular cleaning will help prolong the life of your LCD screen surface and pen. Keep the DTF-521 and pen in a clean, dry place and avoid extremes in temperature. Room temperature is best. The DTF-521 and pen are not made to come apart. Taking apart the product will void your warranty.

**Important:** Take care to never spill liquids onto the pen display or pen. Be especially careful of getting the display, or pen buttons and tip wet – they contain sensitive electronic parts that will fail if liquids enter them.

## **CLEANING**

To clean the DTF-521 casing or the pen, use a soft, damp cloth; you can also dampen the cloth using a very mild soap diluted with water. Do not use paint thinner, benzine, alcohol, or other solvents to clean the unit casing or pen.

To clean the display screen, use an anti-static cloth or a slightly damp cloth. When cleaning, apply only a light amount of pressure to the display screen and do not make the surface wet. Do not use detergent to clean the display screen; this may damage the coating on the screen. Please note that damage of this kind is not covered by the manufacturer's warranty.

## REPLACING THE PEN TIP

The pen tip (nib) will wear with normal use. Excessive pressure will cause the nib to wear sooner. A worn nib may damage the coating on the DTF-521 display screen. To avoid this, periodic tip replacement is recommended.

When the nib gets too short or develops a sharp edge, you can replace it with one of the extra nibs that came with the pen.

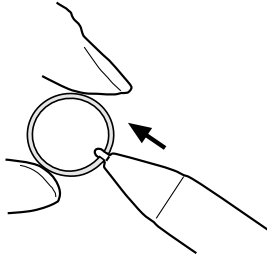

### To remove the old nib:

Clasp it with a Wacom nib removal tool, pair of tweezers, needle-nosed plier, or similar instrument and pull the old nib straight out of the pen.

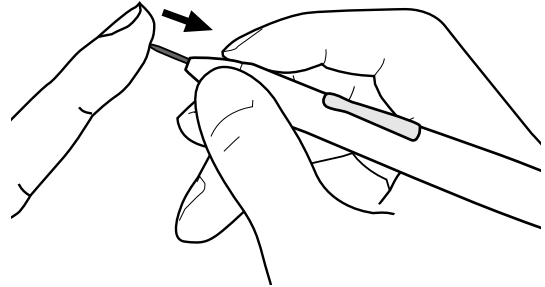

### To insert a new nib:

Slide it straight into the barrel of the pen. Firmly push the nib until it stops. The new nib will slide into the correct position.



**WARNING** Prevent children from swallowing the pen tip or side switch. The pen tip (nib) or side switch may accidentally be pulled out if children are biting on them.

**Important:** When the pen is not in use, place it in the pen tray, the pen storage compartment, or lay it flat on your desk. To maintain the sensitivity of your pen, do not store the tool in a container where it will rest on its tip.

## USING AN ALTERNATE MOUNT OR STAND

If you will be using the DTF-521 in an installation that requires the use of an alternate mounting platform, you can remove the adjustable stand from the unit and mount the pen display onto any mount arm or stand conforming to the VESA 75 mm standard.

Mounting screws that are 4 mm wide with a 0.7 mm pitch (M4 Regular), with a screw clearance depth of 15 mm are required. Exceeding the clearance depth of 15 mm will damage the pen display internal components.

To remove the adjustable stand and attach the pen display to a different mounting platform:

1. Turn off your computer and power off the DTF-521. Then disconnect all cables from between the unit and your computer.
2. Protect the display screen surface by spreading a soft cloth onto a flat table and placing the DTF-521 face down on the cloth.
3. Remove the four screws and lift the adjustable stand assembly away from the body of the unit.
4. Using the appropriate screws for your mounting platform, firmly attach the DTF-521 to the alternate mounting platform.
5. Refer to the *Installation* instructions, beginning on page 10, and reattach the cabling.

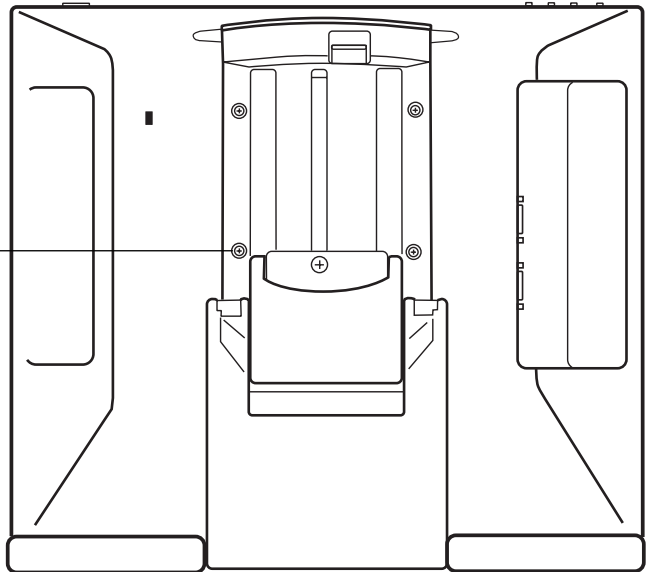

**CAUTION** When attaching the DTF-521 onto an alternate mounting platform, be sure to follow all instructions in the documentation supplied by the platform manufacturer. If improperly installed, the unit could fall, resulting in damage to the unit or physical injury.

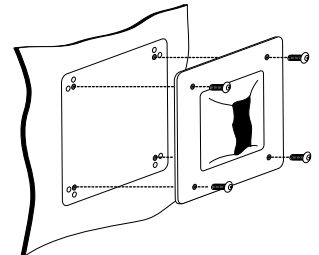

## PEN AND DIGITAL INK CAPABILITIES IN WINDOWS VISTA

Microsoft Windows Vista provides extensive support for pen and touch input. When using DTF-521 with a computer running Windows Vista, your experience is enhanced by powerful note taking, handwriting recognition, fast navigation, and other digital inking options designed to give you quick, intuitive results with the Wacom pen.

- **Note taking.** Use your Wacom pen to jot notes and capture quick sketches in Windows Journal. Journal simulates a physical notebook, but with the advantages of digital note taking – you can choose from a variety of pen, marker, and highlighter tools. Journal also includes a powerful search engine that can even locate your handwritten content.
- **Handwriting recognition.** Because Windows Vista includes powerful handwriting recognition capabilities, you can use your Wacom pen to quickly enter handwritten information anywhere the computer accepts typed input. You can convert your handwritten content to typed text at any time.
- **Gestures.** Use your Wacom pen to make simple gestural movements on the pen display to trigger customizable actions for navigation, editing, and other functions. To customize your gestures, select the FLICKS tab in the PEN AND INPUT DEVICES control panel.
- **Digital Ink in Microsoft Office 2007.** Use your Wacom pen to full advantage with the enhanced digital mark-up and inking tools available in Microsoft Office 2007 applications running on Windows Vista. Found on the REVIEW tab within applicable applications, these tools provide a consistent set of inking options. For quick access, you can add specific inking tools to the Quick Access Toolbar located at the top of each application.

Note that the following workarounds in the pen tablet driver improve drawing performance in Vista:

- The Vista Pen Flicks and 'press-and-hold-to-right-click' features are disabled in graphics applications using the Wintab API.
- There is no pressure sensitivity in Journal and other Vista Ink features when both the Flicks and 'press-and-hold-to-right-click' features are disabled in the Vista PEN AND INPUT DEVICES control panel.



## **ABOUT THE WINDOWS VISTA TABLET PC INPUT PANEL**

The Windows Vista Tablet PC Input Panel enables you to use handwriting or an on-screen keyboard to directly enter text with your Wacom pen. There are a number of ways to launch the Input Panel:

- Click on the Input Panel icon which appears when you move the screen cursor into a text entry area.
- Click on the Input Panel tab, located by default on the left edge of the display screen.
- Click on the Tablet PC Input Panel icon located on the Windows taskbar. If the icon is not visible, right-click on the taskbar, select TOOLBARS, and TABLET PC INPUT PANEL.

To customize the Input Panel:

1. First open the Input Panel and then click on TOOLS in the menu bar.
2. Select OPTIONS to open the Input Panel Options dialog box.
3. Customize the Input Panel settings for the way you like to work.

To learn more about using your Wacom pen in Microsoft Windows Vista and Office 2007, study the documentation that came with your system and Microsoft Office applications. Be sure to take advantage of the Windows Vista training tools, including the Tablet PC tutorial, available from Microsoft. You can visit also the Wacom web site at [www.wacom.com/vista](http://www.wacom.com/vista) for additional information on working with your Wacom pen in Windows Vista.

## UNINSTALLING THE DTF-521

Follow the appropriate procedure below to remove the Wacom tablet software and the DTF-521 from your system.

### Windows:

1. Click on the Windows START button and open the CONTROL PANEL.
2. In the CONTROL PANEL window for
  - Windows Vista: click on UNINSTALL A PROGRAM. In the dialog box that appears, choose the PEN TABLET option and click on the UNINSTALL button.
  - Windows XP or XP x64: select ADD OR REMOVE PROGRAMS. In the ADD OR REMOVE PROGRAMS window, choose PEN TABLET and click on the REMOVE button.
  - Windows 2000: double-click on the ADD/REMOVE PROGRAMS icon. In the dialog box that appears, choose the PEN TABLET option and click on the ADD/REMOVE... button.
3. Follow the prompts to remove the tablet driver. (If prompted, enter your administrator login name and password.)
4. When the driver has been removed, shut down your system, power off your computer, and turn off the DTF-521. When your computer and the DTF-521 are off, disconnect the DTF-521 from your computer.

### Macintosh:

1. From the GO menu, choose APPLICATIONS and open the WACOM TABLET folder.
2. Double-click on the REMOVE TABLET icon and select the REMOVE TABLET SOFTWARE button. Enter your administrator login name and password.
3. After the removal is completed, click OK.
4. Shut down your computer and turn off the DTF-521. When your computer and the DTF-521 are off, disconnect the DTF-521 from your computer.

# PRODUCT SPECIFICATIONS

## GENERAL SPECIFICATIONS

Physical dimensions (W x D x H)	344.0 x 300.0 x 49.0 mm (13.6 x 11.8 x 1.9 in), excluding stand
Weight	4.6 kg (10.1 lb), including stand
Input voltage	12 VDC
Power consumption	23W or less
Operating temperature and humidity	5° to 35° C, 20 to 80% RH (non-condensing)
Storage temperature and humidity	-10° to 60° C, 20 to 90% RH (non-condensing) (maximum storage humidity is 38% at a temperature of 60° C, and maximum storage temperature is 42° C at a humidity of 90%)
Certification and compliance	FCC part 15 class B, Industry Canada Class B, CE, EDID 1.3, C-tick, BSMI, MIC, CCC, The European Union RoHS Directive 2002/95/EC

## DISPLAY

Display	a-Si TFT active matrix LCD
Screen size	15.0 in, diagonal
Signal inputs	VGA (Analog RGB)
Signal outputs	VGA (Analog RGB)
Resolution	1024 x 768 pixels (XGA), 800 x 600 pixels (SVGA), 640 x 480 pixels (VGA)
Refresh rate	45 to 70 Hz (vertical) in XGA mode, 45 to 75 Hz (vertical) in other modes All scan modes are non-interlaced.
Pixel pitch	0.297 x 0.297 mm (0.012 x 0.012 in)
Color depth	16.2 million (6 bits for RGB + FRC)
Brightness	250 cd/m <sup>2</sup> (typical)
Contrast ratio	500:1
Plug and Play	DDC2B
LCD quality	Each DTF-521 LCD panel is produced under very stringent quality standards. Production techniques cannot guarantee an absolutely perfect TFT display. Wacom does not allow any pixel to be always white or always black. A small number of pixels (4 or less) are allowed to show a wrong color for some parts of the color spectrum. This does not mean the display is defective.

## PEN TABLET

Reading technology	Electromagnetic resonance method
Active area	304.1 x 228.1 mm (11.98 x 8.99 in)
Resolution	20 lpmm (0.05 mm) (508 lpi (0.002 in))
Accuracy	±1 pixel
Reading height	5 mm (0.2 in)
Maximum report rate	100 points/sec.
Pressure levels	512 levels
Communication interface	USB v2.0
Integrated USB hub	USB v2.0 Powered hub with two external ports, 500 mA per port

## POWER ADAPTER

Input voltage	100 to 240 VAC, 50/60 Hz
Output voltage	12 VDC, 3.33 A

## PEN (MODEL FP-320)

Pressure levels	512
Pen tip travel	0.2 mm (0.008 in) or less
Physical dimensions (L x D)	147.5 x 12.5 mm (5.81 x 0.49 in)
Weight	12 g (0.42 oz), approximately
Side switch type	Rocker switch

## ORDERING PARTS AND ACCESSORIES

To purchase parts and accessories, refer to the Wacom tablet Read Me file and see who to call for your region.

You can also do the following:

**To purchase parts and accessories in the USA or Canada**, call 1.888.884.1870 (toll-free) or visit Wacom's web site at <http://www.WacomDirect.com> (USA only).

**To purchase parts and accessories in Europe**, call +49 (0)180.500.03.75 or send an email to [spareparts@wacom.eu](mailto:spareparts@wacom.eu). Or, visit [www.wacom.eu/solutionstore](http://www.wacom.eu/solutionstore). You can also contact your local dealer, distributor, or technical support using the appropriate number for your region.

**To purchase parts and accessories in other countries**, please contact your local dealer or distributor.

Please note that not all parts and accessories may be available in all regions.

## **RADIO AND TELEVISION INTERFERENCE**

The equipment described in this manual generates, uses, and can radiate radio-frequency energy. If it is not installed and used properly – that is, in strict accordance with applicable instructions – it may cause interference with radio and television reception.

### **FEDERAL COMMUNICATIONS COMMISSION (FCC) NOTICE**

This device complies with Part 15 of the FCC Rules. Operation is subject to the following two conditions: (1) this device may not cause harmful interference, and (2) this device must accept any interference received, including interference that may cause undesired operation.

This equipment has been tested and found to comply with the limits for a Class B digital device, pursuant to Part 15 of FCC Rules. These limits are designed to provide reasonable protection against harmful interference in a residential installation.

This equipment generates, uses and can radiate radio frequency energy and, if not installed and used in accordance with the instructions, may cause harmful interference to radio communications. However, there is no guarantee that interference will not occur in a particular installation.

You can determine whether the equipment is causing interference by powering it off. If the interference stops, it was probably caused by the equipment.

If the equipment does cause interference to radio or television reception, you may be able to correct the interference by using one or more of the following measures:

- Rotate the television or radio antenna until the interference stops.
- Move the equipment farther away from the television or radio.
- Plug the equipment and computer into an outlet that is on a different circuit from the television or radio.

If necessary, consult your Wacom dealer or an experienced radio/television technician for help.

Changes or modifications to this product not authorized by Wacom could void the FCC Certification and negate your authority to operate the product.

## **INDUSTRY CANADA (CANADA ONLY)**

### **Industry Canada, Class B**

“This Class (B) digital apparatus complies with Canadian ICES-003”

“Cet appareil numérique de la classe (B) est conforme a la norme NMB-003 du Canada.”

## **CE DECLARATION**

The DTF-521 pen display has been tested and found to comply to the following harmonized European Norms:

- EN 55024: 1998+A1:2001+A2:2003 (electromagnetic immunity)
- EN 55022: 1998+A1:2000+A2:2003, Class B (electromagnetic emissions)
- EN 61000-3-2: 2000, Class D (electromagnetic emissions)
- EN 61000-3-3: 1995+A1:2001 (electromagnetic emissions)

The Wacom power adapters have been tested by their manufacturers and found to comply to the following harmonized European Norms:

- EN 55024: 1998+A1:2001 (electromagnetic immunity)
- EN 55022: 1998+A1:2000, Class B (electromagnetic emissions)
- EN 61000-3-2: 2000, Class D (electromagnetic emissions)
- EN 61000-3-3: 1995+A1: 2001 (electromagnetic emissions)
- EN 60950: 2000 (safety)

Based on the results of these tests, Wacom declares that the above mentioned device conforms to the European Council Directive 89/336/EEC, and their amendment Directive 93/68/EEC and indicates this conformity by the CE-sign on each device.

The device must be installed and operated always in strict accordance to the instructions given in this manual. Any changes or modifications to this product that were not specifically authorized by Wacom will invalidate this declaration.

# **WARRANTY (WORLDWIDE, EXCEPT FOR EUROPE, AFRICA AND MIDDLE EAST)**

## **LIMITED WARRANTY**

Wacom warrants the product, to the original consumer purchaser, except for the Software and consumable items such as the pen nibs, to be free from defects in materials and workmanship under normal use and service for a period of two (2) years, from the date of original retail purchase, as evidenced by a copy of the receipt and registration with Wacom within 30 days of purchase.

The Software is licensed “as is.” Wacom makes no warranty with respect to its quality or performance. Wacom cannot guarantee you uninterrupted service or the correction of any errors.

*Upon discovery of a defect in the product, except in the Software, within the Warranty Period, you should contact Wacom Technical Support via telephone, email, or fax to obtain an RMA (Return Merchandise Authorization) number and instructions for shipping the product to a service location designated by Wacom. You should send the product, shipping charges prepaid, to the designated service location, accompanied by the return authorization number, your name, address and telephone number, proof of purchase date, and a description of the defect. Wacom will pay for return shipping by United Parcel Service or by an equivalent service as chosen by Wacom.*

Wacom’s sole obligation and entire liability under this warranty shall be, at Wacom’s option, either the repair or replacement of the defective product or parts thereof of which Wacom is notified during the Warranty Period; provided, however, that you are responsible for (i) the cost of transportation of the product to the designated service location and (ii) any loss or damage to the product resulting from such transportation.

Wacom shall have no responsibility to repair or replace the product if the failure of the product has resulted from accident, abuse, misuse, negligence, or unauthorized modification or repair, or if it has been handled or stored other than in accordance with Wacom’s storage instructions.

Any descriptions, drawings, specifications, samples, models, bulletins, or similar material, used in connection with the sale of the product, shall not be construed as an express warranty that the product will conform or comply with your requirements.

EXCEPT FOR THE LIMITED WARRANTY DESCRIBED ABOVE, THERE ARE NO OTHER WARRANTIES MADE BY WACOM ON THIS PRODUCT. NO ORAL OR WRITTEN INFORMATION OR ADVICE GIVEN BY WACOM, ITS DEALERS, DISTRIBUTORS, AGENTS, OR EMPLOYEES SHALL CREATE A WARRANTY OR IN ANY WAY INCREASE THE SCOPE OF THIS WARRANTY, AND YOU MAY NOT RELY ON ANY SUCH INFORMATION OR ADVICE. THIS WARRANTY GIVES YOU SPECIFIC LEGAL RIGHTS, AND YOU MAY ALSO HAVE OTHER RIGHTS WHICH VARY FROM STATE TO STATE.

WACOM LIMITS THE DURATION OF ANY LEGALLY IMPLIED WARRANTIES INCLUDING IMPLIED WARRANTIES OF MERCHANTABILITY OR FITNESS FOR A PARTICULAR PURPOSE, TO THE DURATION OF WACOM’S EXPRESS WARRANTY. SOME STATES DO NOT ALLOW LIMITATIONS ON HOW LONG AN IMPLIED WARRANTY LASTS, SO THE ABOVE LIMITATION MAY NOT APPLY TO YOU.

NEITHER WACOM NOR ANYONE ELSE WHO HAS BEEN INVOLVED IN THE CREATION, PRODUCTION, OR DELIVERY OF THIS PRODUCT SHALL BE LIABLE FOR ANY DIRECT, CONSEQUENTIAL, OR INCIDENTAL DAMAGES (INCLUDING DAMAGES FOR LOSS OF BUSINESS PROFITS, BUSINESS INTERRUPTION, LOSS OF BUSINESS INFORMATION AND THE LIKE) ARISING OUT OF THE USE OF OR INABILITY TO USE SUCH PRODUCT, EVEN IF WACOM HAS BEEN ADVISED OF THE POSSIBILITY OF SUCH DAMAGES. SOME STATES DO NOT ALLOW THE EXCLUSION OR LIMITATION OF INCIDENTAL OR CONSEQUENTIAL DAMAGES, SO THE ABOVE LIMITATION OR EXCLUSION MAY NOT APPLY TO YOU.

In the event that any of the above limitations are held unenforceable, Wacom’s liability for any damages to you or any party shall not exceed the purchase price you paid, regardless of the form of any claim.

This Limited Warranty is governed by the laws of the United States of America and the state of Washington.

This Limited Warranty is valid for and only applies to products purchased and used inside the United States (and its territories or possessions) and Canada.

## **WARRANTY SERVICE IN THE U.S.A. AND CANADA**

To obtain Warranty service within the U.S. or Canada contact:

Wacom Technical Support

Phone: 1.360.896.9833

Fax: 1.360.896.9724

Inquiry form: <http://www.wacom.com/productsupport/email.cfm>

E-mail: [support@wacom.com](mailto:support@wacom.com)

## **WARRANTY SERVICE OUTSIDE OF THE U.S.A. AND CANADA**

For products purchased or used outside of the United States and Canada, the warranty period is one (1) year from the date of original purchase. Upon discovery of a defect in the product, except in the Software, within the Warranty Period you should contact your local dealer or distributor. If an authorized Wacom repair center is not available in your local country you will be responsible for all transportation costs including duties and taxes to and from the Wacom repair center. In all other respects, the terms of the warranty as set forth above apply to such sales.

Should you have any questions about this Agreement, or if you desire to contact Wacom for any reason, please contact in writing:

### **In North and South America contact:**

Wacom Technology Corporation

1311 SE Cardinal Court

Vancouver, Washington 98683

U.S.A.



# **WARRANTY (EUROPE, AFRICA AND MIDDLE EAST)**

## **SOFTWARE LICENSE AGREEMENT**

### **Important Notice to Customers**

This product contains copyrighted computer programs (“software”) which are the inalienable intellectual property of Wacom Europe GmbH (“Wacom”). This software is both integrated within the product and also contained on the accompanying data carrier. The purchase of this product from your dealer does not include Wacom’s software and the associated rights of usage. Wacom grants you, the user, the right to use the software solely in accordance with the conditions of this software license agreement. By purchasing this product you agree to the terms of this license.

### **ENTITLEMENT TO USE THE SOFTWARE**

Wacom grants the customer a personal, non-exclusive license to use the software solely in combination with this product and for the proper operation of this product. This license may be transferred only in connection with this product.

The use of this software includes solely the permanent or temporary, complete or partial copying of the software by means of loading, displaying, executing, transmitting or saving for the purpose of executing the commands and data it contains or of observing, examining or testing the functions of the software.

The customer may not license, lease or loan the software to a third party, nor allow a third party to access the software in any other way. The customer may not without prior written authorization from Wacom copy, modify, transmit or edit the software, apart from the actions of copying necessary to create a backup copy and for the purposes outlined in section 2 above.

The customer may not decompile the software; if the software contains interfaces to software which is not supplied by Wacom, Wacom shall make the necessary information available to the customer upon request, provided that the customer can prove his/her entitlement to use the software and that he/she agrees to pay the copying and postage costs.

### **LIMITED WARRANTY**

Wacom warrants to you as the original end-user that the product hardware is free from defects in materials and workmanship under normal use and service for a period of TWO (2) YEARS after the date of purchase (excluding consumable items such as the pen nibs), provided that they are unused at the time of such purchase. Wacom further warrants to you the accompanying data media against defects in materials and workmanship for a period of SIX (6) MONTHS after the date of purchase.

The Software is licensed and distributed “AS IS”. Wacom makes no warranties, expressed or implied, with respect to its quality, performance, merchantability and fitness for a particular purpose (including related manuals and documentation). Wacom cannot guarantee you uninterrupted service or the correction of any errors.

Upon discovery of a defect in the product, except in the Software, within the applicable Warranty Period, you should return them in the original packaging to the place of your original purchase, together with your name, address, telephone number, a description of the problem and a copy of the original invoice. You are responsible for any loss or damage to the product resulting from such transportation. Wacom’s sole obligation and entire liability under this warranty shall be, at Wacom’s option, either the repair or the replacement of product or parts thereof that prove defective and that were returned within the applicable Warranty Period.

Wacom shall have no responsibility to repair or replace the product if (a), in the opinion of Wacom, the failure of the product has resulted from accident, abuse, misuse, negligence, misapplication, or unauthorized modification or repair, or (b) the product has been handled or stored other than in accordance with Wacom's storage instructions, or (c) the failure is due to normal wear and tear, or (d) you fail to fulfill your obligations as described above.

In case that any claim presented under warranty is found upon investigation to be either outside the duration or the scope of this warranty, or in case that the product is found to be not defective, then the cost of such investigation and repair shall be borne by you.

Any descriptions, drawings, specifications, samples, models, bulletins, or similar material, used in connection with the sale of the product, shall not be construed as an express warranty that the product will conform or comply with your requirements.

Should any provision of this agreement be declared invalid, that provision shall be treated as separate from the agreement, and the agreement shall remain in force without limitation in all other respects.

If this product is found to be defective, the purchaser may be entitled to institute legal proceedings against the seller on grounds of liability for deficiency. The statutory rights indicated with regard to the seller are not limited in any way by this warranty. Rather, this warranty affords the purchaser rights in addition to those indicated in the present text.

This limited warranty shall apply if the seller's corporate domicile is in the European Union or in Iceland, Norway, Jersey, Switzerland, Russia, the Ukraine, Rumania, Bulgaria, Croatia, Serbia, Tunisia, Turkey, Syria, the Lebanon, Jordan, Israel, Egypt, the United Arab Emirates, Iran or South Africa.

This Limited Warranty and Liability is governed by the laws of the Federal Republic of Germany.

Should you have any questions about this Agreement, or if you desire to contact Wacom for any reason, please contact in writing:

Wacom Europe GmbH  
Europark Fichtenhain A9  
47807 Krefeld  
GERMANY

**Wacom Technology Corporation**

1311 SE Cardinal Court  
Vancouver, WA 98683  
U.S.A.

**Telephone**

General: +1.360.896.9833

Fax: +1.360.896.9724

**Wacom Co., Ltd.**

2-510-1 Toyonodai  
Otone-Machi, Kitasaitama-Gun  
Saitama, 349-1148  
Japan

Internet: <http://tablet.wacom.co.jp>

**Wacom China Corporation**

1108 Block One, Kuntai International Bldg,  
12 Chao Wai Street, Chao Yang District  
Beijing, China 100020

**Telephone**

General: +86.10.5879.0880

Fax: +86.10.5879.0102

**Wacom Australia Pty. Ltd.**

Level 5, 18 Orion Rd,  
Lane Cove West NSW 2066, Australia

**Telephone**

General: +61.2.9422.6700

Fax: +61.2.9420.2272

**Wacom Europe GmbH**

Europark Fichtenhain A9  
47807 Krefeld  
Germany

**Telephone**

General: +49.(0)2151.3614.0

Fax: +49.(0)2151.3614.111

**Wacom Co., Ltd.**

Asia Pacific Office  
Harmony Tower 18F, 1-32-2 Hon-Cho,  
Nakano-Ku, Tokyo 164-0012  
Japan

**Telephone**

General: +81.3.5309.1513

Fax: +81.3.5309.1514

**Wacom Digital Solutions Co., Ltd.**

Gangnam Telepia B/D 9th Fl, 662-18  
Yeoksam-dong, Gangnam-gu, Seoul, 135-080  
Korea

**Telephone**

General: +82.2.557.3894

Fax: +82.2.557.3895

**Wacom Singapore Pte. Ltd. (Singapore)**

3 Bishan Place,  
CPF Bishan Building #06-08  
Singapore 579838

**Telephone**

General: +65.6258.8640

Fax: +65.6258.8697

# DTF-521

interactive pen display

**Installation Guide & User's Manual**