



# USER'S MANUAL

## Interactive Pen Display

Model:

DTU-1031 and DTU-1031X Interactive Pen Display

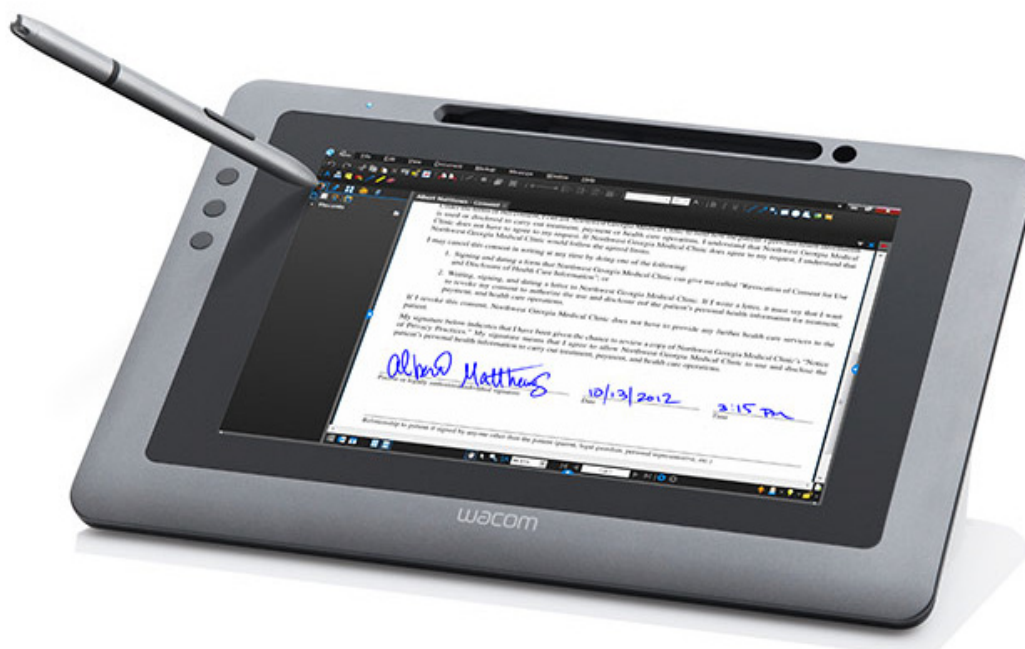

[Installation](#)

[Using the pen](#)

[Using and customizing the Radial Menu](#)

[Customizing the ExpressKeys](#)

[Application-specific settings](#)

[Troubleshooting](#)

[Technical support options](#)

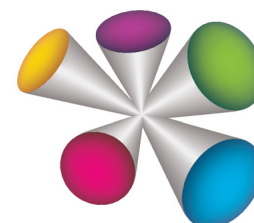



Interactive pen display

User's Manual

Version 2.0, H1914

Copyright © Wacom Co., Ltd., 2014

All rights reserved. No part of this manual may be reproduced except for your express personal use.

Wacom reserves the right to revise this publication without obligation to provide notification of such changes.

Wacom does its best to provide current and accurate information in this manual. However, Wacom reserves the right to change any specifications and product configurations at its discretion, without prior notice and without obligation to include such changes in this manual.

The above year indicates when this manual was prepared. However, the date of release to the users of the manual is simultaneous with the introduction into the market of the applicable Wacom product.

Wacom is a registered trademark of Wacom Co., Ltd.

Adobe and Reader are either registered trademarks or trademarks of Adobe Systems Incorporated in the United States and/or other countries. Microsoft, Windows, and Vista are either registered trademarks or trademarks of Microsoft Corporation in the United States and/or other countries. Apple, the Apple logo, and Macintosh are trademarks of Apple Computer, Inc., registered in the U.S. and other countries.

Any additional company and product names mentioned in this documentation may be trademarked and/or registered as trademarks. Mention of third-party products is for informational purposes only and constitutes neither an endorsement nor a recommendation. Wacom assumes no responsibility with regard to the performance or use of these products.





# CONTENTS

About the manual	4	Removing application-specific settings	36
Navigating the manual	5	<b>TROUBLESHOOTING</b>	37
<b>YOUR INTERACTIVE PEN DISPLAY</b>	6	Testing the interactive pen display	38
Pen display features	7	Testing your pen	39
Front view	7	Display troubleshooting	40
Rear view	8	General display problems	40
Pen display incline options	9	Pen tablet troubleshooting	41
Pen features	10	General problems	41
Pen Tether	10	Windows-specific problems	44
<b>INSTALLATION</b>	11	Macintosh-specific problems	45
System requirements	11	Technical support options	47
Step 1: Pen display installation	12	Obtaining driver downloads	48
Step 2: Pen tablet installation	13	<b>APPENDIX</b>	49
USB cable installation	13	Caring for the interactive pen display	49
Adding other display devices	14	Replacing the pen tip	50
<b>WORKING WITH THE INTERACTIVE PEN DISPLAY</b>	15	Using an alternate mount or stand	51
Ergonomics	15	Uninstalling the interactive pen display	52
Pen display orientation	15	Managing preferences	53
Using the pen	16	Installing multiple tablets	54
Holding the pen	16	Pen and digital ink capabilities in Windows	55
Positioning	16	About the Windows Tablet PC Input Panel	56
Clicking	17	Product information	57
Dragging	17	Ordering parts and accessories	57
Using the pen switch	18	Warranty Service in the U.S.A. and Canada	58
Working with pressure sensitivity	18	Warranty Service Outside of the U.S.A. and Canada	58
Working with multiple monitors	18	<b>GLOSSARY</b>	59
Using the ExpressKeys	19		
<b>CUSTOMIZING</b>	20		
Opening the control panel	20		
Control panel overview	21		
Calibrating and adjusting the pen display	23		
Customizing the pen	24		
Adjusting tip feel and double-click	24		
Advanced tip pressure settings	25		
Customizing Pen mode and options	26		
Customizing the ExpressKeys	27		
Function settings	28		
Using and customizing the Radial Menu	32		
Working with Display Toggle	33		
Application-specific settings	34		
Creating an application-specific setting	35		
Changing application-specific settings	36		





## ABOUT THE MANUAL

This document provides quick access to information about your interactive pen display. Click on a navigation button or highlighted word to move through the document. The information is common to Windows and Macintosh computers. Windows screen captures are shown, unless otherwise noted.

If you are new to electronic documentation, read [navigating the manual](#).

- Go directly to [Contents](#) or [Index](#) topics by clicking on them.
- SMALL CAPITAL LETTERS identify the names of keyboard keys, dialog boxes, and Control Panel options.
- You can use your viewer zoom-in tool to increase the size of the page on your display screen.
- The following information is not included with this product: information about your specific computer hardware or operating system, or information about your application software. Your best source for this information is the set of manuals and discs that came with your hardware, operating system, or application.
- Many applications have built-in support for pen display features (such as pressure sensitivity). Visit Wacom's web site to find a listing of applications that support these features (see [product information](#)).
- For information on how best to use pen display features within a specific application, see the instructions in that application's manuals.

Wacom's philosophy is to continually improve all of its products. As a result, engineering changes and improvements are made from time to time. Therefore, some changes, modifications, and improvements may not be covered in this document.





## NAVIGATING THE MANUAL

Use the navigation controls to move through the manual:



Go to front page.

Contents

Go to table of contents.

Index

Go to index.



Go back to previous view.



Page back, or page forward.

Adobe® Reader® provides additional tools for using and printing the manual. See the Adobe Reader help for more information.





## YOUR INTERACTIVE PEN DISPLAY

This manual describes the [installation](#) and [use](#) of interactive pen display DTU-1031 or DTU-1031X.

The Wacom Control Panel enables you to customize your pen and pen display settings. To learn more, see [customizing](#).

[Pen display features](#)

[Pen display incline options](#)

[Pen features](#)

The following information is not included with this product: information about your specific computer hardware or operating system, or information about your application software. Your best source for this information is the set of manuals and discs that came with your hardware, operating system, or application.

Note: Not all product models are available in all regions.

For illustrations of the items included with your pen display, see the Quick Start Guide included in the product box.



## PEN DISPLAY FEATURES

Familiarize yourself with the features and components of your product.

### FRONT VIEW

The features of the DTU-1031 pen display are illustrated below and listed in the Pen Display Features box. See [Using the ExpressKeys](#) for descriptions and a table of default ExpressKey functions.

Note: The DTU-1031X does not have ExpressKeys.

Place the pen into the storage compartment by inserting the nib end of the pen into the left side of the compartment with the side switch up. Gently press the pen into the compartment. Take care not to damage the pen nib.

Note: The DTU-1031 pen has a side switch, and the DTU-1031X pen does not. The DTU-1031 pen can be used with the DTU-1031X. To obtain a DTU-1031 pen, please contact your Wacom representative.

To place the cover on the pen compartment, position the cover with the pen nib outline facing to the left. Align the cover with the top of the pen compartment and press the cover into place.

Remove the pen by pressing on the pen tip side near the top notch to eject the opposite end from the compartment, being careful not to damage the pen nib. Grasp the pen and remove.

The pen can also be placed upright in the pen stand, or secured to the pen display with the pen tether provided (see [Pen Tether](#)).

DTU-1031 ExpressKeys are shown as 1 through 4, from top to bottom (standard Landscape mode)

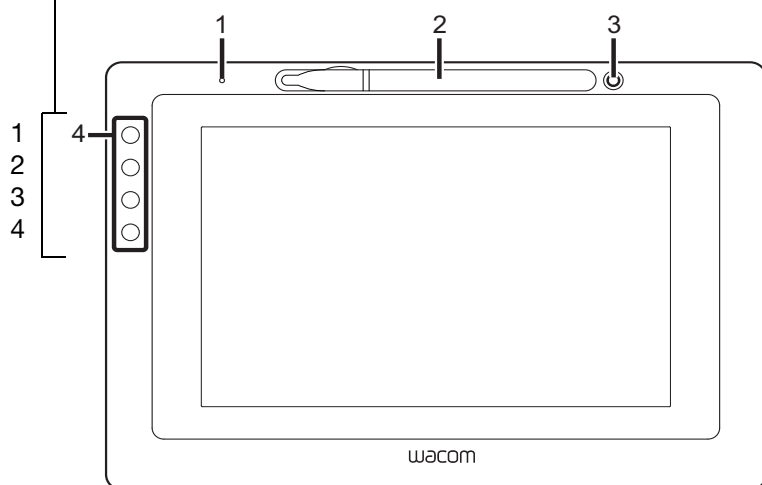

#### Pen Display Features

- 1 - Status LED
- 2 - Pen storage compartment
- 3 - Pen stand
- 4 - ExpressKeys

#### Pen Display Orientation Options

- Landscape (shown) - ExpressKeys left
- Landscape Flip - ExpressKeys right
- Portrait - ExpressKeys top
- Portrait Flip - ExpressKeys bottom

## REAR VIEW

The features of your pen display are illustrated below and listed in the Pen Display Features box.

You can connect a security cable to the Security slot to prevent theft.

The pen can be secured to the pen display through the pen tether holes with the pen tether provided (see [Pen Tether](#)).

The USB port is used to connect the pen display to your computer. See [Step 2: Pen tablet installation](#).

The leg stands can be used to incline the pen display. See [Pen display incline options](#).

The pen display can be mounted to articulated arms or other third-party stands meeting the VESA specification for display stands. For details, see [Using an alternate mount or stand](#).

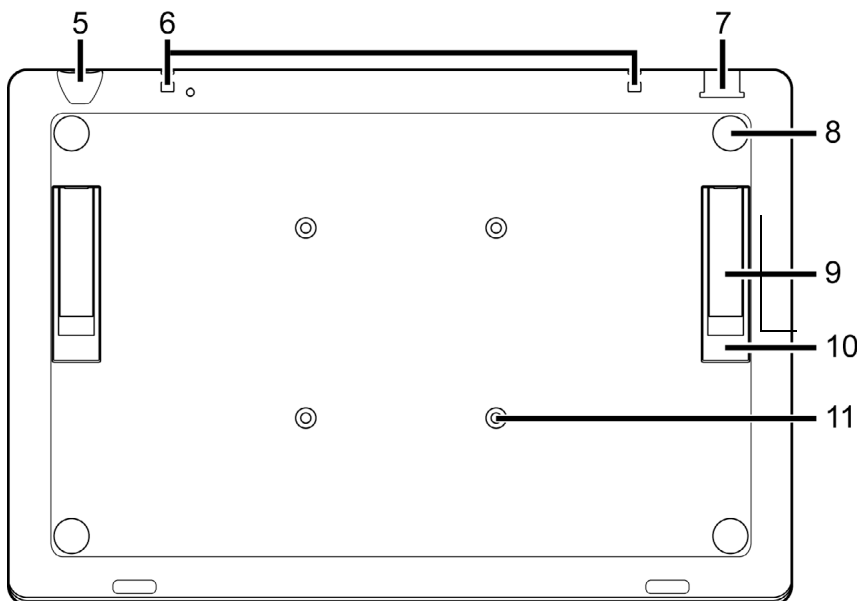

### Pen Display Features

5 - Security lock slot

6 - Pen tether holes

7 - USB port

8 - Rubber foot

9 - Short leg stand, 15 degrees  
(DTU-1031)

10 - Long leg stand, 20 degrees  
(DTU-1031)

11 - VESA mount holes

Note: The DTU-1031X has one leg  
stand, 18 degrees





## PEN DISPLAY INCLINE OPTIONS

You may want to place the pen display flat on your desk while you work. However, stand legs recessed into the back allow you to adjust your pen display to two different angles for working and viewing. The diagram shows the location of the stand legs for the DTU-1031.

DTU-1031:

- To set the pen display to a 15-degree angle, pull out the two shorter legs.
- To set the pen display to a 20-degree angle, pull out the two longer legs.

DTU-1031X: Pull out the stand legs to set the pen display to an 18-degree angle.

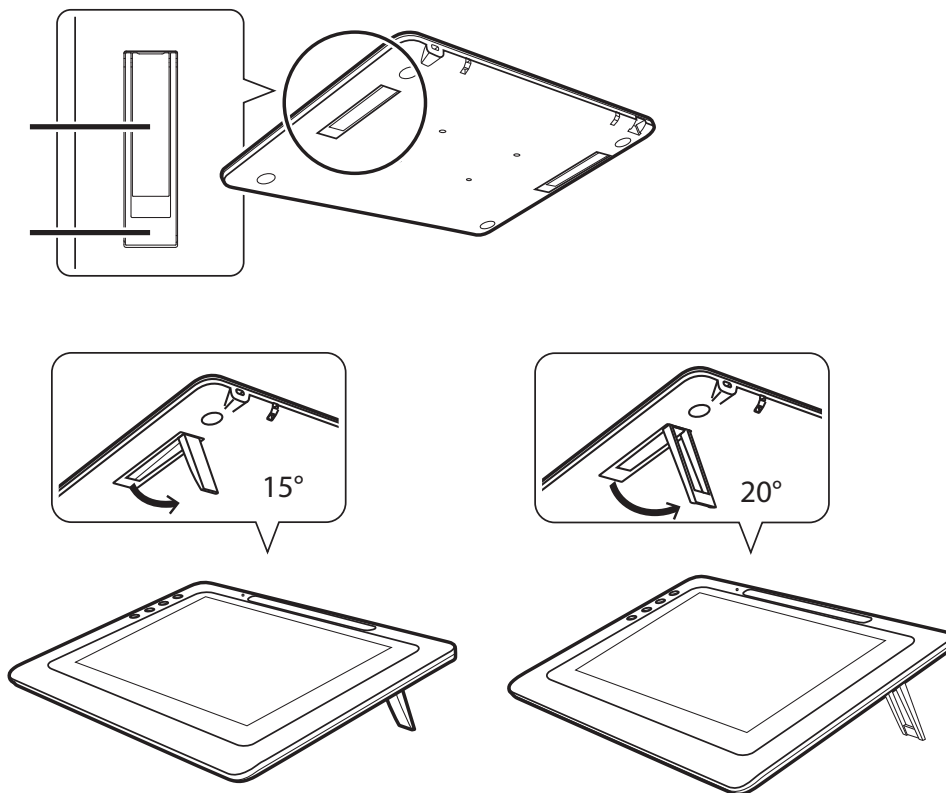



## PEN FEATURES

**Pen switch):** Be sure the pen's programmable switch is in a convenient location where you can toggle it with your thumb or forefinger but not accidentally press it while using the pen. You can use the switch whenever the pen tip is within proximity of the display screen surface; you do not need to touch the pen tip to the display surface.

**Note:** The DTU-1031 pen has a side switch, and the DTU-1031X pen does not. The DTU-1031 pen can be used with the DTU-1031X. To obtain a DTU-1031 pen, please contact your Wacom representative.

**Pen tip (replaceable nib):** The pen is activated as soon as it is brought within proximity (5 mm/.2 inch) of the pen display screen. This allows you to position the screen cursor without touching the pen tip to the display screen.

When pressure is applied to the pen tip, the pen simulates a primary mouse button click. Tip click pressure can be adjusted in the Wacom Control Panel.

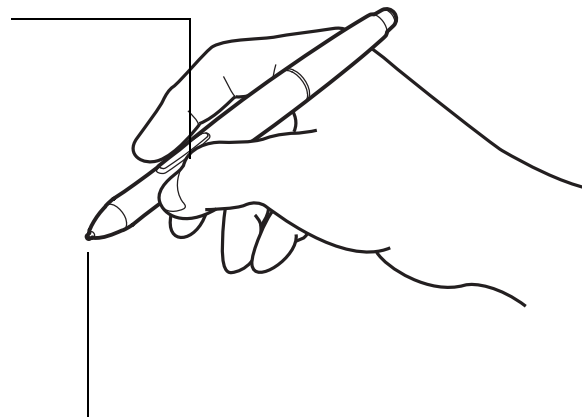

### Notes:

When not in use, place the pen in the pen storage compartment or the pen stand, or lay it flat on your desk. To maintain the sensitivity of your pen, do not store it in a position where it will rest on its tip.

Place the pen into the storage compartment by inserting the nib end of the pen into the left side of the compartment with the side switch up. Gently press the pen into the compartment. Take care not to damage the pen nib.

**Important:** Use only a pen specified for use with your pen display. Other pens may not function properly. Also, the pen tip is specifically designed for use with the pen display. If your pen display has a coated surface, the tips on other pens could damage the pen display screen.

## PEN TETHER

A pen tether to secure the pen to the pen display is provided. The pen is secured by threading the tether through the hole at the end of the pen and one of the tether holes at the top of the pen display. The attachment holes for the tether are shown in the Rear view.





## INSTALLATION

The computer treats the interactive pen display as two separate devices (the display and the pen tablet). Therefore, the installation process is completed in two stages:

- First install as a display.
- Then install as a pen tablet.

Both stages require hardware and software installations and adjustments. Carefully follow ALL instructions.

**Important:** You **MUST** install the Wacom driver software for correct pen-on-screen functionality.

[System requirements](#)

[Step 1: Pen display installation](#)

[Step 2: Pen tablet installation](#)

## SYSTEM REQUIREMENTS

Make sure your computer meets the following minimum system requirements.

DTU-1031:

- **PC.** Windows 8, Windows 7, Vista™, or XP (32-bit). Available USB port and CD-ROM drive.
- **Macintosh.** OS X, v10.7 or greater. Available USB port, and CD-ROM drive.

DTU-1031X:

- **PC.** Windows 8, Windows 7, or XP (32-bit and 64-bit). Available USB port and CD-ROM drive.
- **Macintosh.** OS X, v10.7 or greater. Available USB port, and CD-ROM drive.

Note: Wacom recommends that you use both USB connectors to ensure adequate power for the pen display. However, your system may operate satisfactorily with just one USB connector attached to your computer.





## STEP 1: PEN DISPLAY INSTALLATION

In this step, the interactive pen display is installed as a monitor on your system. In addition, a second software application will be installed to allow the pen display to work properly. The additional applications are DisplayLink for the DTU-1031, and Magic Control Technology (MCT) for the DTU-1031X.

Begin the installation by completing the first two steps below. Then follow the directions for the DTU-1031 or DTU-1031X section to install the additional application.

**Important:** You MUST install the Wacom software and the DisplayLink (DTU-1031) or MCT (DTU-1031X) software for correct pen-on-screen functionality. You cannot use a DTU-1031 and DTU-1031X connected to the same computer at the same time.

1. Save your work and close all open applications. Temporarily disable any virus protection programs.
2. Insert the Installation CD into your computer's CD-ROM drive. If the software installer menu does not automatically display, double-click on the INSTALL icon located on the CD. You can also download and install the latest software driver from the Wacom website for your region.
3. Click INSTALL TABLET and follow the prompts to install the drivers for the pen display.
  - On Mac OS, the DisplayLink or MCT driver will also be installed during this process.
  - On Windows, the DisplayLink or MCT driver will be installed automatically when you connect your pen display to your computer for the first time.
  - You can also download and install the DisplayLink driver from [www.DisplayLink.com](http://www.DisplayLink.com), and the MCT driver from [www.wacom.com](http://www.wacom.com).
  - See Notes 3 and 4 below for information on re-installing and uninstalling drivers.
4. Reactivate your virus protection program.
5. If you have trouble installing the pen display, see [troubleshooting](#).

### Notes:

1. Driver installation automatically activates the new pen input functions available within Microsoft Windows 8, Windows 7, Vista, and XP (except for Windows Starter and Home Basic, and Windows Vista Home Basic). User-specific preferences are supported. After logging in, each user can customize their personal settings in the Wacom Control Panel. Switching to another user will automatically load the settings for that user.
2. On the Macintosh, you must restart your computer after installing the Wacom driver.
3. If you installing the Wacom and MCT drivers on a DTU-1031X, you must first uninstall any Wacom or DisplayLink drivers already on the system. To uninstall the driver for the tablet, DisplayLink or MCT, see [uninstalling the interactive pen display](#).
4. If you do not use the provided CD for Wacom tablet driver installation, for example if you download the Wacom driver from the Wacom website, DisplayLink or MCT will not install. You will need to download the DisplayLink driver, or the MCT driver, from the websites shown in step 3 of the procedure above, and install it separately. You can also reinstall either driver by using the Wacom Installation CD. However, on the DTU-1031X, you will need to uninstall any Wacom tablet or DisplayLink drivers before reinstalling.
5. DisplayLink does not support 64-bit Windows XP, and MCT does not support Windows Vista.
6. If the pen display does not respond properly or you lose cursor control, the pen display preferences may be corrupted. You can delete the current preference settings and return the pen display to its factory default condition. See [managing preferences](#).





## STEP 2: PEN TABLET INSTALLATION

In this step, the interactive pen display is installed as a pen tablet.

### USB CABLE INSTALLATION

1. Place your pen display face-down near your computer, using a soft cloth underneath the pen display to protect the surface.
2. Plug the square end of the USB cable into the USB port of the pen display.
3. Place the USB cable attachment on the USB cable as shown, to prevent it from becoming unplugged. If you need to remove the attachment, press in on both sides of the attachment and lift up.

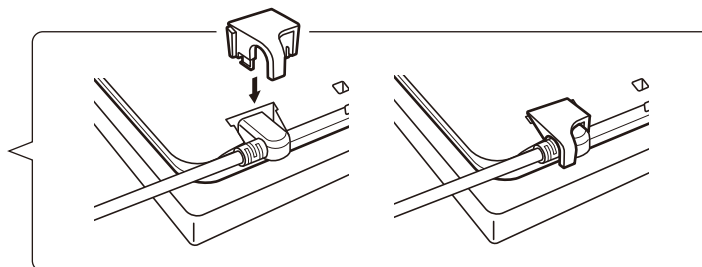

4. Turn the pen display face up.
5. Plug the two connectors at the other end of the USB cable into two available USB ports on your computer.  
**Note:** Wacom recommends that you use both of these USB connectors to ensure adequate power for the pen display. However, your system may operate satisfactorily with just one USB connector attached to your computer.
6. Turn on your computer.
7. Check the status light (LED) on your pen display. When there is a connection between the computer and the pen display, the status light is dimly lit. When the computer and pen display are connected and the pen is in proximity of the display surface, the status light changes to a steady blue.
8. After completing the software installation (Step 1), make sure you can use your pen on the interactive pen display to move the screen cursor.
9. When you place the pen tip on the display screen, the screen cursor should immediately jump to a corresponding position approximately beneath the pen tip. Lift the pen tip and place it on the display screen surface in a different location. The screen cursor should again jump to the new position. This is known as absolute positioning, and enables you to position the screen cursor without having to drag your pen across the display screen surface.
10. See [calibrating and adjusting the pen display](#) to precisely align the screen cursor to the pen tip.
11. To change the brightness of the pen display, adjust the Brightness setting in the Wacom Control Panel (see [Customizing](#)).

**Note:** Windows: If you are using the pen display as a secondary display, you may first need to enable the pen display in your display properties Control Panel.





## ADDING OTHER DISPLAY DEVICES

You can connect another display device to your computer's VGA or DVI connector for use with the pen display. When working with more than one monitor, the pen display will map to the monitors based on how your system is configured. By default, if you are in mirror mode, the pen display will map to the entire space on each monitor.

Note: Make sure you complete the pen display installation before connecting another device to the unit.

The [Display Toggle](#) function is available for use on systems with more than one monitor. This enables you to toggle the screen cursor between the pen display and other monitors.

Refer to your hardware and operating system documentation for information on connecting other monitors to your computer and configuring your system for use with multiple monitors. Be sure to use the correct cable and connector when adding an additional device to your system.

For troubleshooting tips, see [troubleshooting](#).

Notes for the pen display screen:

Each interactive pen display LCD panel is produced under very stringent quality standards. Production techniques cannot guarantee an absolutely perfect display, and some panels may exhibit a certain number of pixels that show an incorrect color.

If an image has fine striping (such as screen stripes), it may appear to flicker or display a moiré pattern.

Do not apply excessive pressure on the display screen surface; it may cause the appearance of a moiré or pooling pattern. If this occurs, use less pressure on the display screen when working with the pen.

When a still image is displayed for a long period of time, an after-image may remain for a short time. To prevent this, use a screen saver or other power management feature.

To extend the life of the pen display backlight, set your computer's power management to turn off the display when it is not in use for extended periods of time.





## WORKING WITH THE INTERACTIVE PEN DISPLAY

As you work with the pen display you can rest your hand lightly on the display screen, just as if it were a sheet of paper.

Because the pen display surface will be a little higher than your desk, consider adjusting the height of your desk or chair to assure comfortable use of the device.

[Ergonomics](#)

[Using the pen](#)

[Working with multiple monitors](#)

[Customizing Pen mode and options](#)

### ERGONOMICS

To minimize fatigue, comfortably organize your work area. Position your pen display, the pen, and your keyboard for easy access without unnecessary reaching. The pen display and any other displays should be positioned so you can view them comfortably with a minimum of eyestrain.

- Take short breaks between tasks to stretch and relax your muscles.
- Use a gentle grip when working with the pen.
- Alternate tasks throughout the day.
- Maintain a good posture at all times. Minimize awkward postures and repetitive movements that cause discomfort.
- Change your position if you feel any discomfort due to your work position.

#### Tip:

The pen display can also be mounted to articulated arms or other third-party stands meeting the VESA specification for display stands. For details, see [using an alternate mount or stand](#).

### PEN DISPLAY ORIENTATION

Your pen display can be rotated for use in one of two landscape orientations, or one of two portrait orientations. These positions are listed in the Pen Display Orientation Options list (see [Pen Display Orientation Options](#)). Refer to your hardware and operating system documentation for information on setting the pen display to your preferred orientation.



## USING THE PEN

The pen is cordless, battery-free, and senses the amount of pressure you apply to the tip.

[Holding the pen](#)

[Positioning](#)

[Clicking](#)

[Dragging](#)

[Using the pen switch](#)

[Working with pressure sensitivity](#)

[Working with multiple monitors](#)

## HOLDING THE PEN

Hold the pen like you would a normal pen or pencil. As you work with the interactive pen display you can rest your hand lightly on the display screen. You can tilt the pen in any way that feels most comfortable.

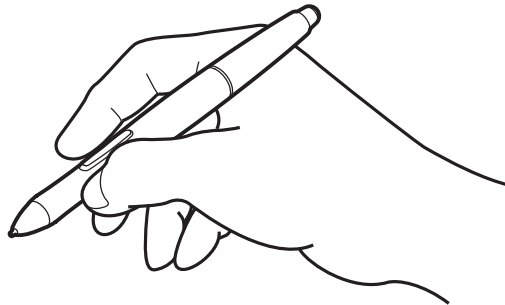

For information on changing the pen settings, see [customizing](#).

## POSITIONING

To position the screen cursor, move the pen slightly above the pen display screen without touching the screen surface. Press the pen tip on the display screen to make a selection.

Note: [Calibrating and adjusting the pen display](#) ensures correct alignment of the screen cursor with the pen tip. If the screen cursor does not jump to a position near the pen tip when you place the pen on the display screen, the pen display software driver may not be installed or is not loading. Re-install the driver software if necessary. Also see [troubleshooting](#).

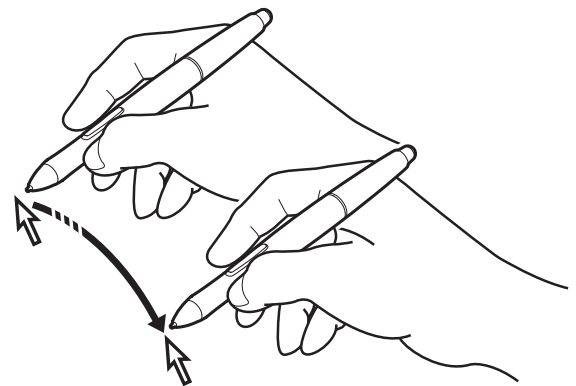





## CLICKING

Tap the display screen once with the pen tip, or touch the pen to the display screen with enough pressure to register a click.

**Windows tip:** To make navigating with the pen easier, configure Windows to select when the pen is over an icon and to launch the icon with a single click. To turn on this feature, first open a folder.

**For Windows 8, Windows 7 and Vista:** From the ORGANIZE pull-down menu choose FOLDER AND SEARCH OPTIONS. From the GENERAL tab select SINGLE-CLICK TO OPEN AN ITEM (POINT TO SELECT). Note: Vista is not supported on the DTU-1031X.

**For Windows XP:** From the TOOLS pull-down menu choose FOLDER OPTIONS.... From the GENERAL tab select SINGLE-CLICK TO OPEN AN ITEM (POINT TO SELECT).

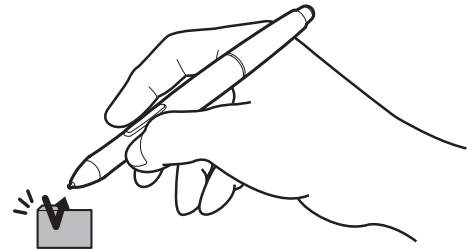

Press the switch if it is set to DOUBLE CLICK, or quickly tap the display screen twice in the same place with the pen tip. Double-clicking is easier when the pen is perpendicular to the pen display screen.

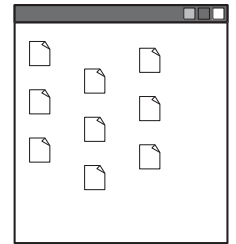
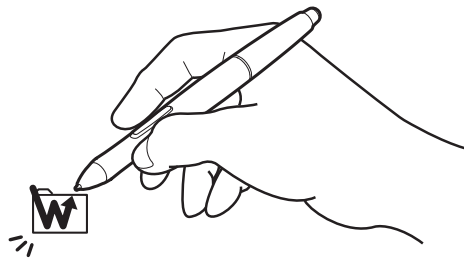

## DRAGGING

Select an object, then slide the pen tip across the display screen to move the object.

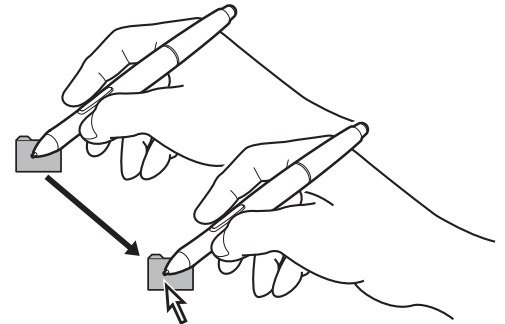



## USING THE PEN SWITCH

The pen has a programmable switch that can be used whenever the pen tip is within proximity (5 mm (0.2 inch)) of the display screen surface. You do not need to touch the pen tip to the display surface in order to use the switch. By default, the switch is set to RIGHT CLICK. The switch function can be modified or disabled using the Wacom Control Panel. See [customizing](#).

## WORKING WITH PRESSURE SENSITIVITY

The pen responds to the nuance and inflection of your hand movements, enabling you to create natural-looking pen strokes within applications that support this feature. To annotate and write with pressure, select a pressure-sensitive tool from your application's tool palette. As you work on the screen surface, use various amounts of downward pressure on the tip of the pen.

## WORKING WITH MULTIPLE MONITORS

When you are working with the pen display and additional monitors on the same system, the screen cursor movement on the standard monitors will depend on your system configuration.

If a second monitor is connected in mirror mode, both the pen display and the other monitor will show identical images and screen cursor movement.

If you are using the pen display with other monitors in extended monitor mode, you have the following options for navigating on the other monitors:

- Set the pen switch to the DISPLAY TOGGLE function. You can then press the switch to toggle the screen cursor between the pen display and your other displays. For example, your product can be used as a pen display (the screen cursor is positioned at the pen tip location) or toggled for use as a standard Wacom tablet (the screen cursor can be moved across the entire desktop or additional displays). See [Working with Display Toggle](#) for more information.
- Set the pen switch to MODE TOGGLE. You can then quickly switch between pen mode for working on the pen display and mouse mode for working on the other monitors.
- Set an ExpressKey to DISPLAY TOGGLE or MODE TOGGLE function.





## USING THE EXPRESSKEYS

Press individual keys to perform frequently used functions or keystrokes. ExpressKeys can also be used to modify your pen properties as you work. Please note that there are no ExpressKeys on the DTU-1031X.

Default settings are shown by ExpressKey numbers, which are numbered 1 through 4 from top to bottom and shown in [Front view](#). Use the Wacom Control Panel to set other functions for the ExpressKeys (see [Customizing](#)).

ExpressKey Number	Function
1	Radial Menu
2	SHIFT
3	CTRL
4	ALT

ExpressKeys can also be operated in combination with one another. When you press both keys at the same time, a combination function is initiated.





## CUSTOMIZING

After mastering the basics of using your pen on the interactive pen display, you may want to customize the way your product works. This chapter describes how to use the Wacom Control Panel to adjust your pen display and pen settings.

Advanced users can learn how to further optimize the pen display by creating [application-specific settings](#).

[Opening the control panel](#)

[Control panel overview](#)

[Calibrating and adjusting the pen display](#)

[Customizing the pen](#)

[Function settings](#)

[Using and customizing the Radial Menu](#)

[Working with Display Toggle](#)

[Application-specific settings](#)

## OPENING THE CONTROL PANEL

You customize the pen display from the Wacom Control Panel. See [control panel overview](#). To open it, use the pen on the pen display:

**Windows 8:** From the Windows 8 Start screen, click the WACOM TABLET PROPERTIES tile. If you are using the Windows 8 Classic Desktop, press the Windows key on your keyboard, or select the Windows icon in the Charms bar, to access the Start screen.

**Windows 7, Vista and XP:**

Click on the Windows START button and choose ALL PROGRAMS. Then select WACOM TABLET and choose the WACOM TABLET PROPERTIES option.

**Macintosh:**

1. Open SYSTEM PREFERENCES from the Apple menu or from the APPLICATIONS folder.
2. Click on the WACOM TABLET icon.

**Note:** User-specific preferences are supported. After logging in, each user can customize their personal settings in the Wacom Control Panel. Switching to another user will automatically load the settings for that user.



## CONTROL PANEL OVERVIEW

Use the Wacom Control Panel to customize the pen display. When you open the Control Panel, an icon for the pen is displayed in the TOOL list and the appropriate tabs are displayed.

To customize the pen and pen display, make your changes to the tab controls. Experiment with different settings to find what works best for you. Any changes you make will take effect immediately. You can always click DEFAULT to return to the factory settings.

Note: [Application-specific settings](#) are for advanced users.

The upper portion of the Control Panel displays icons representing your pen display (TABLET), TOOL, and APPLICATION settings.

Choose FUNCTIONS to customize the [Radial Menu](#) settings. [Display Toggle](#) options are also available on multiple monitor systems.

Choose PEN to customize your pen settings.

Displays advanced options.

Displays an information dialog, and an option to access the DIAGNOSTICS dialog.

Displays this manual.

Tabs display customizable settings for the selected TOOL.

Tool Tips are available for most Control Panel items. Simply position the screen cursor over an item and let it rest there; in a few moments the Tool Tip will pop up.

Additionally, your keyboard tab and arrow keys can be used to navigate the Control Panel.

**Control panel lists and tabs:** The Wacom Control Panel TABLET, TOOL, and APPLICATION lists allow you to select the pen display or tablet, tool, or application for which you want to change settings.

The TABLET list displays an icon for any supported pen display or tablet that has been installed on your system and is currently connected. All settings shown below this list apply to the selected pen display or tablet.

- The Wacom Control Panel will not launch unless a supported pen display or tablet is connected to the computer.
- Settings can only be viewed or changed for an attached pen display or tablet.
- A pen display or tablet cannot be deleted from the Control Panel list unless it is attached to the computer.

See also [installing multiple tablets](#).

The TOOL list displays an icon for the tablet FUNCTIONS and for the PEN.

Note: When the pen is first used on the tablet it is automatically added to the TOOL list, and functions with the default settings. See [customizing the pen](#) for more information.

The APPLICATION list lets you define TOOL settings that only apply to a specific application. See [application-specific settings](#).

Note: The APPLICATION list is for advanced users; it is not necessary to select or add applications to customize your pen.

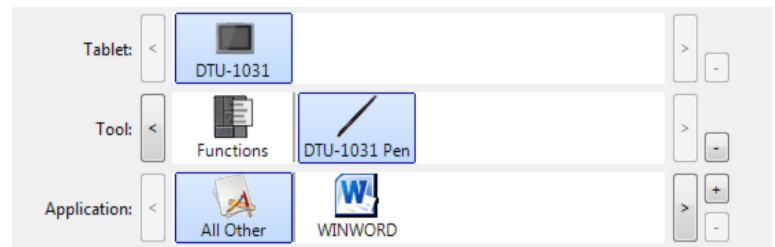

Your current selections are highlighted.

## CALIBRATING AND ADJUSTING THE PEN DISPLAY

You must calibrate the pen display to align the screen cursor with the position of the pen on the display screen. This is required to compensate for viewing angle, and to adjust for parallax caused by the display screen cover glass. Set the pen display in its working position, then follow the procedure.

**Note:** As you do the calibration, read the directions on the calibration screens for detailed instructions and additional options. The calibration setting applies to all applications.

1. Open the Wacom Control Panel.  
If more than one pen display is installed on your system, select the unit you are working with from the TABLET list.
2. Select PEN from the TOOL list.  
Then select the CALIBRATE tab.
3. If you are working with multiple monitors, select the MONITOR corresponding to the pen display. (Only monitors that are set to one of the resolutions supported by the unit will appear in the list.)
4. Click CALIBRATE... to activate the calibration screen.
5. Hold the pen and position yourself as you normally do when working with the pen display. Use the pen tip to click on the center of the crosshairs in the upper-left corner.
6. Then click on the center of each of the crosshairs that appear on the display.
7. On the next dialog that appears, test the alignment by positioning the pen at a few different points on the display. Click OK to accept the calibration. Click TRY AGAIN to recalibrate.

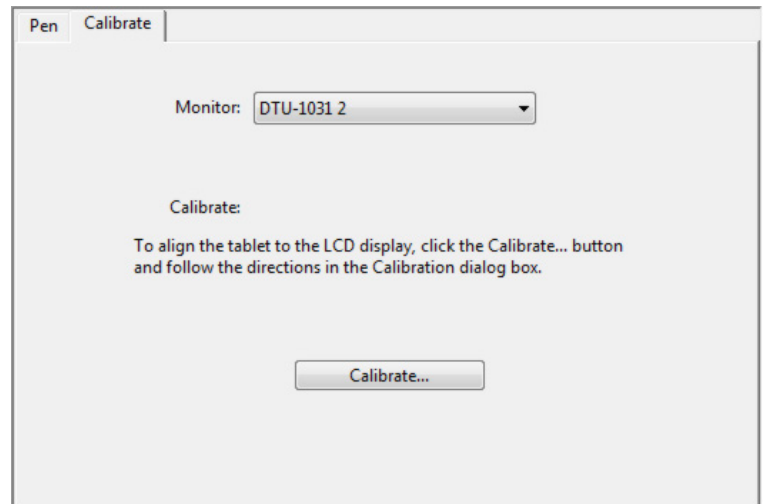

First Crosshairs



Click on each target as it appears. Press ESC or wait a few seconds to cancel.

To make sure that Windows Ink features are available and function correctly when you work with your pen in Windows applications such as MS Office, click the USE WINDOWS INK checkbox.

In other applications, this functionality may produce undesired effects. If this occurs, uncheck the checkbox and try using your pen again.

**Tip:** To see the screen cursor slightly offset from the actual position of the pen tip, calibrate by clicking on a spot showing that offset from the crosshairs. For example, to have the screen cursor appear 2.5 mm (1/10th of an inch) above and to the left of the pen tip, calibrate by clicking on a spot 2.5 mm (1/10th of an inch) below and to the right of the crosshairs.

## CUSTOMIZING THE PEN

To customize your pen, first open the Wacom Control Panel using the pen. The pen will be selected in the TOOL list and the appropriate tabs will be displayed. Select a tab and choose from the available options.

[Adjusting tip feel and double-click](#)

[Advanced tip pressure settings](#)

[Customizing Pen mode and options](#)

[Application-specific settings](#)

## ADJUSTING TIP FEEL AND DOUBLE-CLICK

To adjust the tip sensitivity of your pen, select the PEN tab.

Customizes the amount of pressure needed to click or draw.

To create broad brush strokes or to click with a light touch, use a SOFT tip setting. For maximum control while sketching thin lines, use a FIRM tip setting.

Displays the tip [FEEL DETAILS](#) dialog box where you can further customize the tip sensitivity.

With your screen cursor positioned over an empty area of the Control Panel, press down on the pen display screen with your pen tip to test the current tip feel setting. Use the CURRENT PRESSURE bar to determine how hard you must press on the pen to reach maximum pressure.

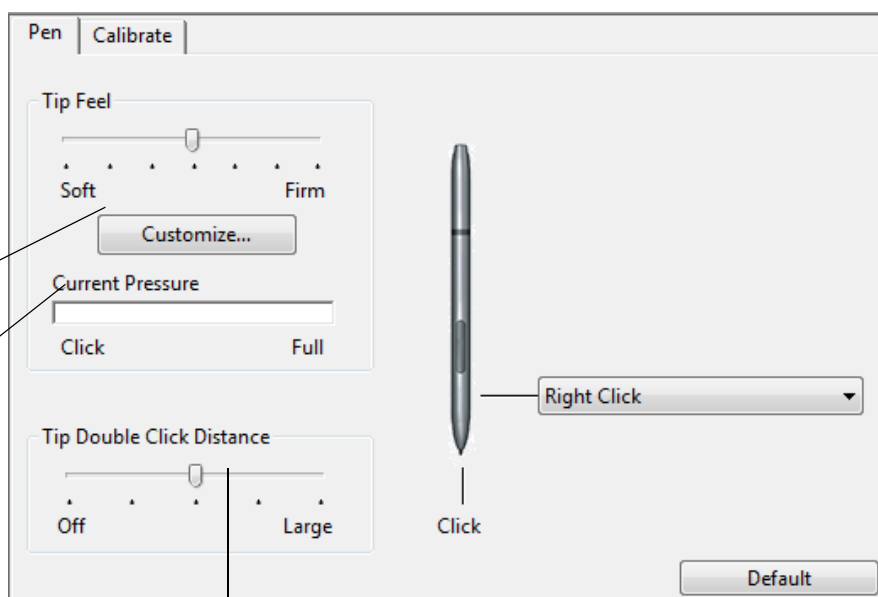

Adjusts the size of the double-click area. A larger setting makes double-clicking easier.

Drag the slider to OFF if you do not want [double-click assist](#).

### Tips:

Use a soft TIP FEEL for a wider range of pressure values with most pressure-sensitive applications.

In some applications a soft pressure setting can make the pen overreact – any small press on the pen is magnified on the screen. If you experience this, try a firmer TIP FEEL setting.

To make double-clicking easier, expand the tap area that accepts a double-click (the double-click distance).

A large double-click distance may cause a delay at the beginning of brush strokes in some graphics applications. If you notice such effects, try setting a smaller double-click distance and using the pen switch to double-click.





## ADVANCED TIP PRESSURE SETTINGS

To customize tip pressure settings, select the PEN and click on the DETAILS... button. The options within the FEEL DETAILS dialog box enable you to change the tip pressure sensitivity and click threshold settings independently. (In the PEN tab, these settings are adjusted simultaneously with the TIP FEEL slider.)

The PROFILE graphically displays the selected pressure SENSITIVITY curve and CLICK THRESHOLD settings. A curve that increases quickly makes the pen feel more sensitive.

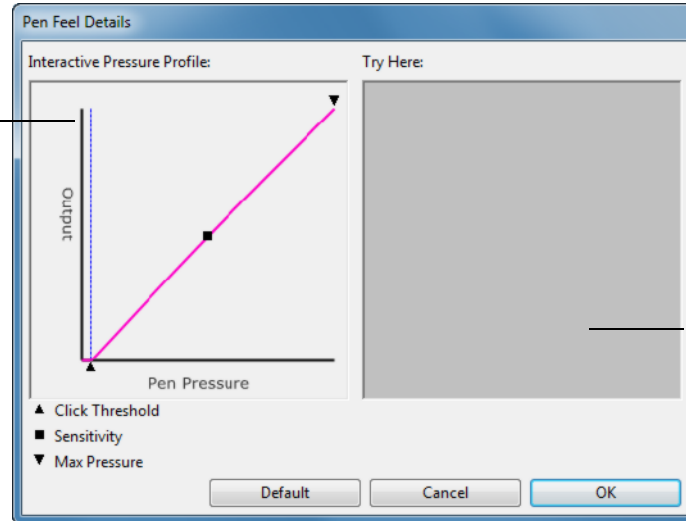

Using your pen tip, make several strokes within the box to test the results of your changes.



## CUSTOMIZING PEN MODE AND OPTIONS

Select the PEN tab to change the functions assigned to the switch and tip of your pen.

Select the functions to perform when pressing the pen switch.

When you bring the pen tip within 5 mm (0.2 inch) of the pen display screen surface without touching the screen and press the pen switch, the selected function occurs.

**Tip:** To make double-clicking easier, set the switch to double-click automatically by selecting **DOUBLE CLICK**.

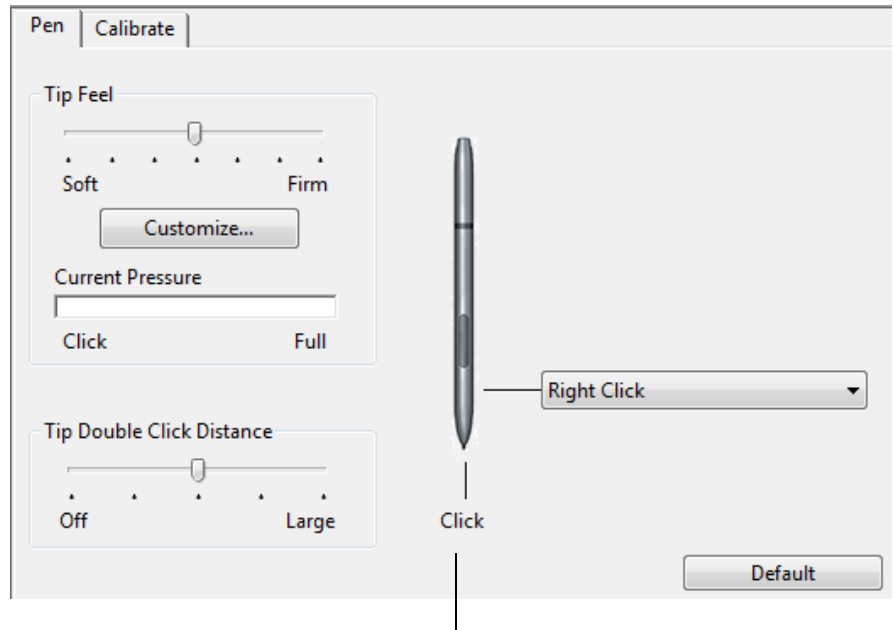

Double-click here to change the function assigned to the pen tip.

**Note:** The tip must be set to **CLICK** in order to draw in most graphics applications.

You can change the **SIDE SWITCH MODE** to best fit the way you like to use the pen when making right-clicks or other click functions.

To access the **SIDE SWITCH MODE** settings, click on the **OPTIONS...** button at the bottom of the main Control Panel. In the **OPTIONS** dialog box:

- Select **HOVER CLICK** to perform click functions without touching the pen tip to the pen display screen surface.
- When **CLICK & TAP** is selected, you must press the pen switch while touching the pen tip to the pen display screen surface in order to perform a click function. **CLICK & TAP** enables the precise placement of your click functions, and is the default setting for Tablet PCs.
- Choose **Right** or **Left** for right-handed or left-handed orientation.
- Use the **Brightness Adjustment** slider to set your preferred brightness for the screen.

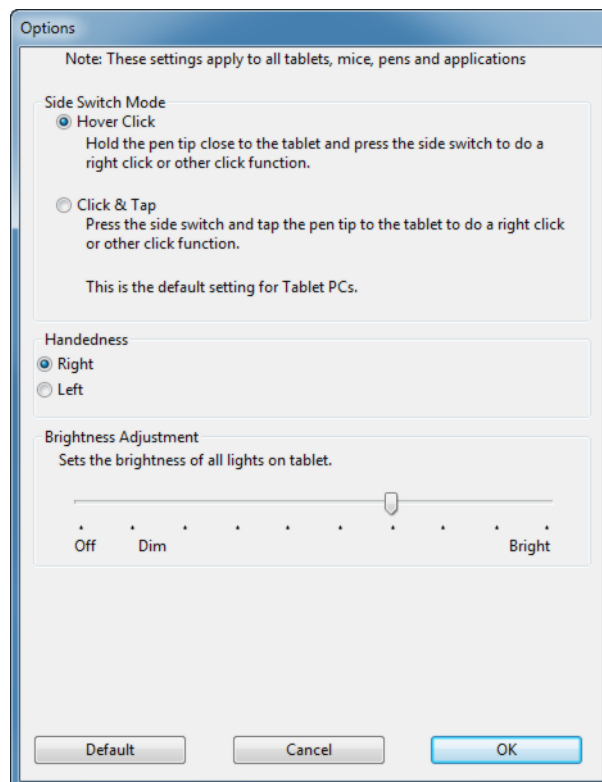

## CUSTOMIZING THE EXPRESKEYS

To customize the ExpressKeys on the DTU-1031, select the EXPRESSKEYS tab. Each key can be customized to perform a Display Toggle, modifier, keystroke, or other function. Please note that there are no ExpressKeys on the DTU-1031X.

Choose a function to perform when the key is pressed. (See [Function settings](#)).

ExpressKey functions can be defined for use with [specific applications](#).

See [Using the ExpressKeys](#) for more information.)

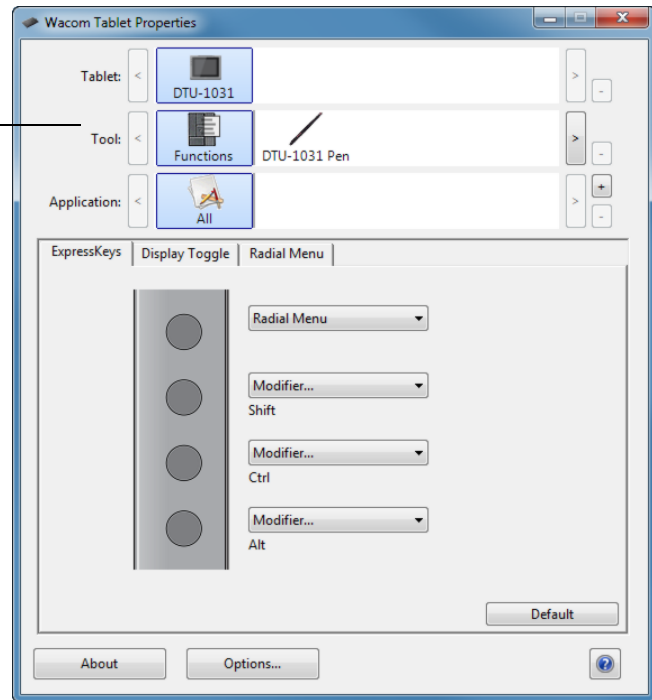

**Important:** Some applications can override and control the ExpressKey functions.



## FUNCTION SETTINGS

The following options are available for pen or Radial Menu settings. Not all options are available for all controls or pen display models.

FUNCTION NAME	DESCRIPTION
CLICKS	
• CLICK	Simulates a primary mouse button click.
• RIGHT CLICK	Simulates a right mouse button click, which displays a context menu. This is the default for the pen switch.
• MIDDLE CLICK	Simulates a middle mouse button click.
• DOUBLE CLICK	Simulates a double-click. For easier double-clicking, use this function instead of tapping twice with the pen tip.
• CLICK LOCK	Simulates holding down the primary mouse button. Press the pen switch once to initiate click lock. Press the switch again to release click lock. Click lock is useful for dragging objects or selecting blocks of text.
• 4TH CLICK	Simulates a 4th mouse button click.
• 5TH CLICK	Simulates a 5th mouse button click.
KEYSTROKE...	<p>Enables you to simulate keystrokes. Select this option to display the DEFINE KEYSTROKE dialog box.</p> <p>Enter a keystroke or keystroke combination in the KEYS entry box. Keystroke combinations can include letters, numbers, function keys (such as F3) and modifier keys (such as SHIFT, ALT, or CTRL for Windows, or SHIFT, OPTION, COMMAND, and CONTROL for Macintosh). You can also select special keystrokes or keystroke combinations from the ADD SPECIAL drop-down menu.</p> <p>After defining a keystroke or keystroke sequence, click OK.</p> <p><b>Important: Because the ENTER (Windows) and RETURN (Macintosh) keys can be selected as a defined keystroke, they cannot be used to select OK. You must use your pen to click on the OK button.</b></p> <p>If prompted, enter a name for the keystroke definition. The name will be displayed with the respective control or in the Radial Menu, as applicable.</p> <p>You can create different keystroke functions for different applications. See <a href="#">application-specific settings</a>.</p>
	<p>Deletes only the last entry in the keystroke entry box.</p> <p>Clears the keystroke entry box</p> <p>Allows you to enter a name for the defined keystroke.</p>

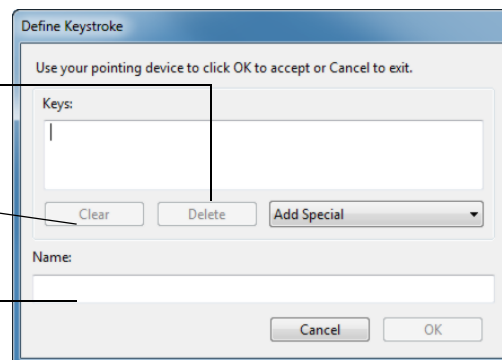



## FUNCTION NAME

## DESCRIPTION

## MODIFIER..

Enables you to simulate modifier keys such as SHIFT, ALT, or CTRL for Windows, or SHIFT, OPTION, COMMAND, and CONTROL for Macintosh). Many applications use modifier keys to constrain the size or placement of objects.

Choose one or more modifier key options. Select the CLICK box if you want a mouse click to occur whenever you press the pen switch.

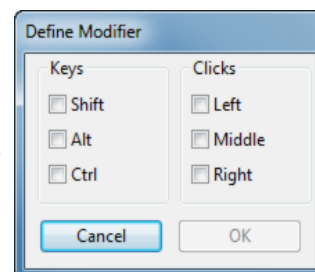

## RADIAL MENU

Displays a [Radial Menu](#) on your screen. Each level of the hierarchical menu consists of eight menu slices which may contain various features and options to choose from.

## BACK

Simulates the BACK command in browser applications.

## FORWARD

Simulates the FORWARD command in browser applications.

## PAN/SCROLL...

Enables you to position a document or image in any direction within the active pane by setting the pen switch to PAN/SCROLL and then dragging with the pen tip across the pen display screen active area.

When you select PAN/SCROLL, the PEN SCROLL SPEED dialog box prompts you to set a scrolling speed for use in applications that do not support grabber hand (pixel-level) panning within a document or image.

A slower setting reduces the scroll rate and is useful for close-up and detail work where you need precise control of the image.

As you move the pen tip, the document or image is repositioned to follow the direction of pen movement on the pen display screen surface.

Release the switch or lift the pen tip from the display screen surface when you are done.

In some application windows the document will precisely follow the screen cursor as you move the pen tip, while in others it will simply move in the same general direction as the screen cursor.

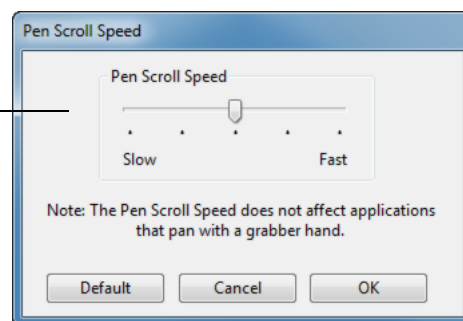



## FUNCTION NAME

## DESCRIPTION

SHOW DESKTOP

Minimizes all open windows to display a clean desktop.

SWITCH APPLICATION

Brings up the application switching dialog with focus on the next open application. On Windows 8, Windows 7 or Vista systems running Aero, Flip 3D will be activated with focus on the next open applications.

OPEN/RUN...

Opens a dialog box where you can select a specific application, file, or script to launch.

Click BROWSE... to locate an application, file, or script to launch. The selection you make appears in the APPLICATION TO RUN box. Click OK to accept the selection.

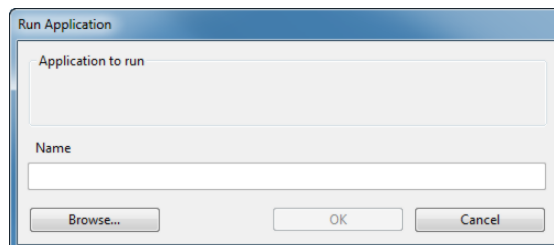

The dialog box will close and the OPEN/RUN... option you have selected will be assigned as your pen switch option. Press the pen switch to launch the assigned option.

If your selection is for the Radial Menu, it will be displayed in the Radial Menu.

INK TOGGLE

(Macintosh.) Toggles the “ink in any application” function of Ink on and off. Ink automatically recognizes and converts your handwriting into text and inserts it into a document. Handwriting recognition must be turned on for this function to work. See your Macintosh help for information on working with Ink.

EXPOSÉ

(Macintosh.) Tiles all open windows. To access this option, first choose KEYSTROKE... and then click on the ADD SPECIAL menu within the dialog box.

PRESSURE HOLD

Locks the pressure at the current pressure level until the switch is released. For example, you can paint with pressure sensitivity until you reach the brush size that you like. You can then press the button and continue painting with the same size brush until the switch is released.

PRECISION MODE

Changes the mapping around the current pen tip position such that you must move the pen twice as far for the screen cursor to cover the same distance on the display screen. To activate, press and hold the pen switch after assigning it to the function. Release the switch to return to normal mapping.

When your pen is in mouse mode, screen cursor movement is adjusted to act as if acceleration were off and speed set to slow.

DISPLAY TOGGLE

For multiple monitor systems. Enables you to toggle the screen cursor between the pen display and your other displays. When selected, your product can be used either as a pen display (the screen cursor is positioned at the pen tip location) or as a standard Wacom tablet (the screen cursor can be moved across the entire desktop or additional displays). See [working with Display Toggle](#).





## FUNCTION NAME

## DESCRIPTION

## MODE TOGGLE...

Toggles between [pen mode](#) and [mouse mode](#). When first setting the pen switch to MODE TOGGLE..., the MOUSE MODE dialog box is displayed and you can adjust the mouse acceleration and speed.

Sets the screen cursor tracking speed when in mouse mode.

Sets the screen cursor acceleration when in mouse mode.

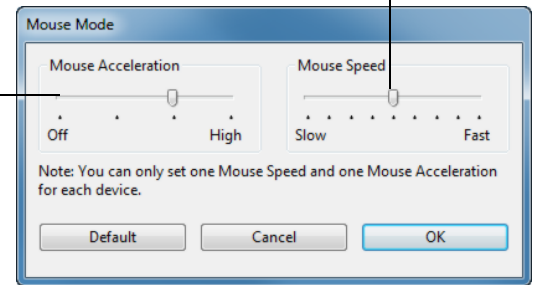

Mouse mode settings can be accessed from a number of different locations within the Control Panel. However, for each pen and application that you are customizing, only one MOUSE ACCELERATION and SPEED setting can be made.

The mouse mode acceleration and speed settings are independent of system settings. Changes you make to these settings in the Control Panel do not affect similar system settings. However, changes made to similar system settings may affect your pen display settings.

## TABLET PC

- TABLET PC INPUT PANEL
- JOURNAL
- TABLET PC DEFINED

(Tablet PCs and Windows systems that support the Tablet PC Input Panel.) Opens the Tablet PC input panel when the pen switch is set to this function.

(Windows and Tablet PC systems that include Microsoft Journal.) Opens Microsoft Journal.

(Tablet PCs and Windows systems that support the Tablet PC Input Panel.) Sets the button function according to settings found in the:

- Windows 8, Windows 7 and Vista TABLET PC SETTINGS and PEN AND INPUT DEVICES control panels.
- Windows XP Tablet Edition TABLET AND PEN SETTINGS control panel.

## DISABLED

Disables the button function.

## APPLICATION DEFINED

Reports only the button number to the application. This is for applications, such as CAD programs, that have built-in tablet support.

## DEFAULT

Returns a button to its default setting.





## USING AND CUSTOMIZING THE RADIAL MENU

To display the Radial Menu, set the pen switch or ExpressKey to the RADIAL MENU function (this is the default for ExpressKey 1). Whenever you press the switch or ExpressKey, the Radial Menu is displayed at the screen cursor position.

- The hierarchical Radial Menu appears in circular format. Each level of the menu consists of eight control slices which may contain various features and options to choose from.
- Select an available option by clicking on it within the Radial Menu. Some selections may display a submenu for additional options. Note: The menu closes after you make a selection.
- To close the Radial Menu without making a selection, click on the 'X' located at the center of the menu or on a control slice that has no function assigned to it.

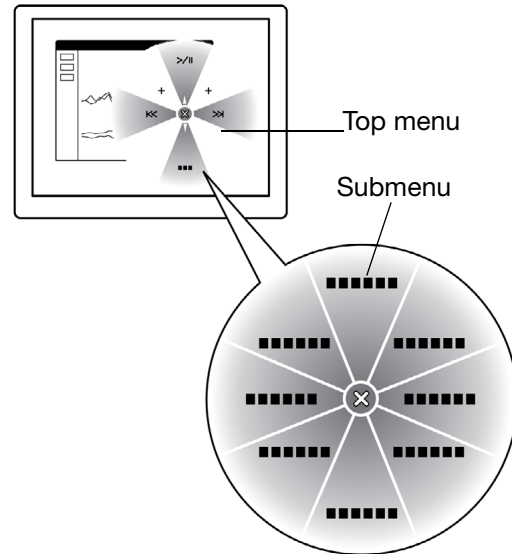

Use the RADIAL MENU tab to customize the available functions on the Radial Menu.

1. Select a control slice.
2. Assign a control FUNCTION to the slice.
3. Select a menu or submenu to customize.
4. Select a control slice for which to customize settings.
5. Choose the function(s) to perform.

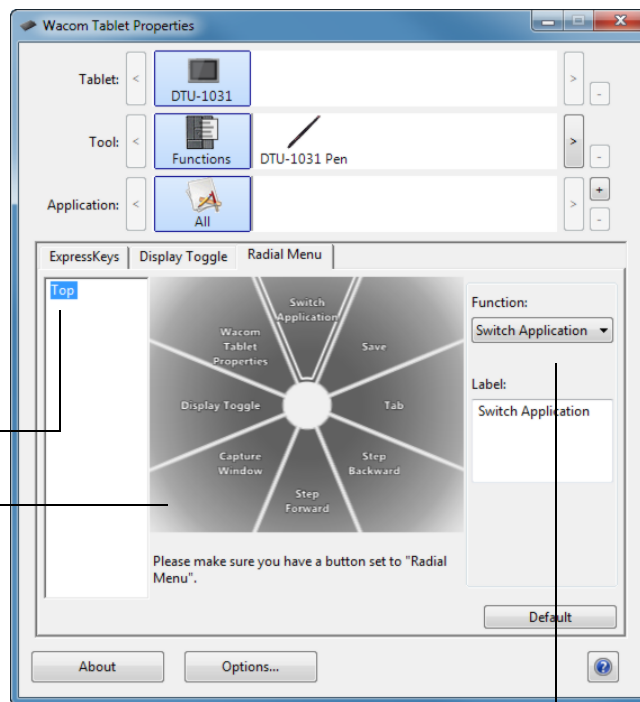



## WORKING WITH DISPLAY TOGGLE

DISPLAY TOGGLE is available on multiple monitor systems. The feature allows you to use your pen on the interactive pen display to navigate the screen cursor to any display on your system. If you set your pen switch to the DISPLAY TOGGLE function, you can press it to toggle the screen cursor between the pen display and your other displays. For example, your product can be used as a pen display where the screen cursor is positioned at the pen tip location, or toggled for use as a standard Wacom tablet where the screen cursor can be moved across the entire desktop or additional displays.

When you open the Wacom Control Panel and the pen display is the selected tablet, the DISPLAY TOGGLE tab will be available if the system has two or more displays. The DISPLAY TOGGLE tab enables you to define how the mapping will be applied to each toggled display.

- When PEN DISPLAY TO DESKTOP is selected and your pen switch has been assigned the DISPLAY TOGGLE function, the screen cursor will toggle from your pen display to the entire system desktop. Pressing the switch a second time returns the screen cursor to the pen display.
- When PEN DISPLAY TO OTHER DISPLAYS is selected and you press the pen switch, the screen cursor is toggled from your pen display to another active pen display or monitor. If additional displays are attached to the system, the screen cursor will toggle to each display in turn until it returns to the pen display from where the initial toggle began.

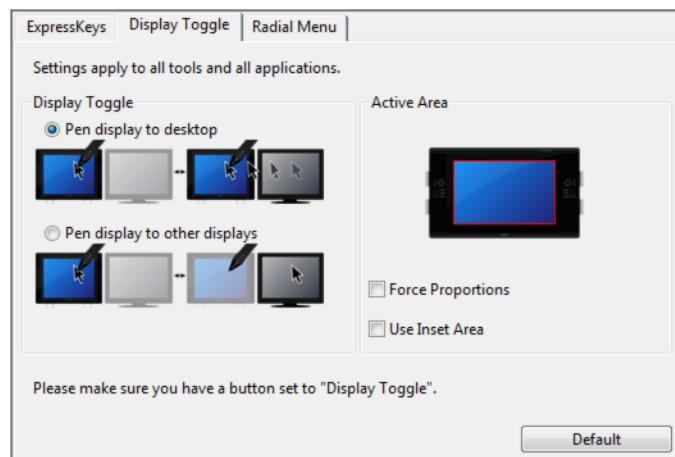

**Important:** If you are using application-specific settings with DISPLAY TOGGLE, make sure the customized application in the APPLICATION list (including ALL OTHER) has the pen switch assigned to DISPLAY TOGGLE.

ACTIVE AREA options enable you to determine the size of the area where the pen is functional on the pen display. When you make a selection, the red indicator updates to illustrate your choice.

- FORCE PROPORTIONS adjusts the size of the tablet's active area to maintain correct vertical and horizontal proportions between the pen display and the entire desktop or newly mapped-to display. Depending on your settings, some portions of the tablet active area may no longer be usable when this option is selected.
- When deselected, the correct scale or proportions are not maintained – for example, sketching a circle on the pen display may create an ellipse on a mapped-to display screen.
- USE INSET AREA limits the tablet's active area to a sizing of 6 x 8 inches. If FORCE PROPORTIONS is also selected, this sizing may be less. When deselected, as much as possible of the entire tablet active area will be used for tablet-to-display mapping.



## APPLICATION-SPECIFIC SETTINGS

You can customize your pen for use with a particular application. For example, you may prefer a firm pen tip pressure setting in one application and a soft pressure setting in another. The APPLICATION list enables you to add an individual application to the list and then customize your settings for that application.

- When no application-specific settings have been created and the pen is selected from the TOOL list, the APPLICATION list displays the ALL icon containing tool settings that apply to all of your applications. In the example below, no application-specific settings have been added for the PEN so the ALL icon is displayed and the PEN will have the same settings in all applications.

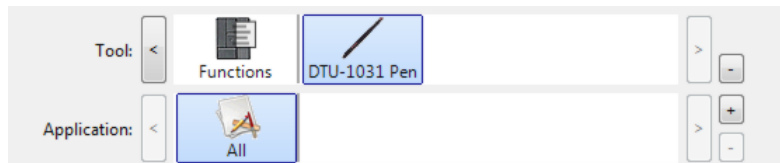

- When application-specific settings are added to the APPLICATION list, the ALL icon changes to ALL OTHER, and an application icon is displayed for the newly added application(s).

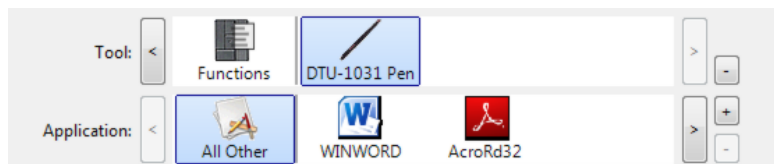

In the above example, application-specific settings have been added for the PEN. If you select the ALL OTHER icon and make changes to the tab settings, your changes will apply to the PEN in all applications EXCEPT those which you have added to the APPLICATION list. If you select an application icon and make changes to the tab settings, your changes will apply to the PEN only while you are using that application.

When you create application-specific settings, you are creating a separate group of settings for the pen and selected application. See the following sections for additional details:

[Creating an application-specific setting](#)

[Changing application-specific settings](#)

[Removing application-specific settings](#)





## CREATING AN APPLICATION-SPECIFIC SETTING

To create an application-specific setting, first choose the pen display and pen for which you want to create an application-specific setting. Then click on the APPLICATION list's [ + ] button to display the ADD APPLICATION FOR CUSTOM SETTINGS dialog box.

Choose from one of two methods to select an application:

- Open the application for which you want to create custom settings, and then select that application from the CURRENTLY OPEN APPLICATIONS BOX.
- BROWSE to select the executable file of any application installed on your computer.

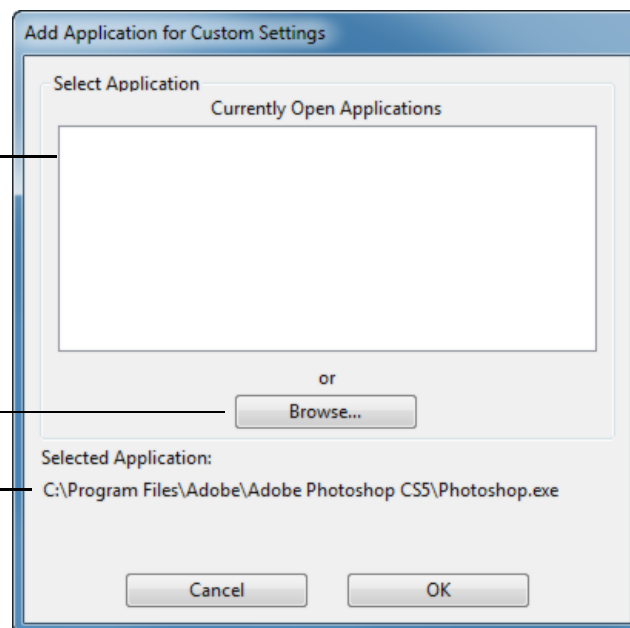

Your selection is added to the SELECTED APPLICATION box, where the name of the selected application will be displayed.

**Note:** If two programs have the same executable file name, they will share the same customized settings.

After adding an application, its icon appears in the APPLICATION list whenever the pen is selected in the TOOL list. Select the application and then customize the Control Panel tab settings for your pen and the selected application.

Once you have created application-specific settings, applications that have not been customized in this manner will use the TOOL settings for ALL OTHER.

**Tip:** First customize settings for one application. When you feel comfortable with the process, you can create more application-specific settings.





## CHANGING APPLICATION-SPECIFIC SETTINGS

To change pen settings for a specific application, select PEN and the application and then customize the tab settings.

## REMOVING APPLICATION-SPECIFIC SETTINGS

To remove an application-specific setting:

1. In the TOOL list, select the PEN. Then, in the APPLICATION list, select the application you want to remove from the list.
2. Click on the APPLICATION list's [ - ] button. In the dialog box that appears, click DELETE to confirm your selection. The selected application is removed from the list, along with any custom pen settings that you may have created for it.

Tip: To quickly remove all application-specific settings from the pen, remove the PEN from the TOOL list. Then place the pen back on the pen display. The PEN will be added back to the TOOL list using the default settings.





## TROUBLESHOOTING

Most of the time your interactive pen display will work flawlessly. But if you are having trouble, Wacom recommends you do the following:

1. If the Wacom driver failed to load properly, first perform the recommended action in any error message that may appear on your screen. If that does not solve the problem, review the troubleshooting procedures in this chapter.
2. If the pen display does not function properly, refer to the troubleshooting sections on the following pages. See also [display troubleshooting](#), or look in the [pen tablet troubleshooting](#). Your problem may be described there and you can try the solution offered.
3. Check the product FAQs (Frequently Asked Questions) on the Wacom web site for your region.
4. If you are having a compatibility conflict between the pen display and a new hardware or software product, consider downloading an updated software driver. Wacom periodically updates the software driver to maintain compatibility with new products. See [obtaining driver downloads](#).
5. If you have tried the suggestions in this guide and still cannot resolve the problem, contact Wacom for Technical Support. See the [technical support options](#) for information on where to obtain support for your region.

[Testing the interactive pen display](#)

[Testing your pen](#)

[Display troubleshooting](#)

[Pen tablet troubleshooting](#)

[Technical support options](#)

[Obtaining driver downloads](#)





## TESTING THE INTERACTIVE PEN DISPLAY

1. If the pen status LED does not light, check the following:
  - If the light is not on, make sure that your computer is turned on and properly connected to the pen display. Make sure the USB cable is firmly connected to the pen display and computer.
2. If there is no display:
  - Make sure that your computer is turned on. The LED will light blue when the proper video signal is received.
  - Make sure that the Wacom tablet and DisplayLink or MCT drivers are installed properly.
  - Make sure the USB cable is firmly connected to the pen display and computer.
3. Verify that the tablet portion of your pen display and pen are working:
  - Press the pen tip against the display and verify that the LED lights blue.
  - If the LED does not light, verify that the USB cable is plugged into an active USB port. If the interactive pen display is plugged into a USB hub, try plugging it directly into the USB port on your computer. If you are using only one USB connector to connect the pen display with your computer, plug in the other connector if you have an additional USB port available on your computer.
  - Be sure that the USB port(s) to which you are connecting has not been disabled. It may be necessary to check your system BIOS setting to verify that you have connected the pen display to an active USB port. The LED will light blue when the pen display is registered as a USB device and the pen tip is pressed against the display.
4. Check the pen. If you cannot make a selection on the display screen with the pen:
  - Test the pen by pressing the pen tip against the surface of the pen display. The LED should light blue.
  - Without applying pressure to the pen tip but keeping the pen within 5 mm (0.2 inch) of the pen display surface, press the pen switch. The LED should again light blue.
  - If the LED does not light blue for these tests, be sure you are using a pen specified for use with your product.
  - See [testing your pen](#) for detailed information.

If you are still having problems, you may have a defective pen or pen display.





## TESTING YOUR PEN

If the pen does not work as you expect, it is a good idea to first check the assigned functions or reset the pen to its default conditions. A quick way to reset a pen to its default settings is to remove it from the TOOL list by clicking on the list's [ - ] button. After the pen has been removed, place it back onto the display screen surface and the pen will be re-added to the TOOL list with its default settings.

Open the Wacom Control Panel and click on the ABOUT button. In the dialog box that appears, click on the DIAGNOSE... button to open the DIAGNOSTICS dialog box. The DIAGNOSTICS dialog box displays dynamic information about the interactive pen display and pen. This information is used when testing the pen display and your pen.

If more than one pen display unit is connected to your system, be sure to select the unit for which you are testing in the TABLET INFO column.

Note: If the pen switch is set to RADIAL MENU or OPEN/RUN..., that function will occur when the switch is pressed. In this case you may want to change the switch's function before testing.

1. While observing the POINTING DEVICE INFO column, bring your pen within 5 mm (0.2 inch) of the display screen. A value for PROXIMITY, the DEVICE NAME, and DEVICE TYPE should be displayed.
2. Move your tool along the pen display screen surface. The X and Y Data values should change to reflect the tool position.
3. Test your pen switch. The pen display status LED should light blue each time you click with the pen tip or press the switch.
  - Press on the display screen surface with the pen tip. The SWITCHES state and PRESSURE value should change. (PRESSURE should change from approximately 0% with no pressure applied to approximately 100% when full pressure is applied.)
  - Next, press the switch without pressing the tip to the display screen surface and the SWITCHES state should change.
4. When you are done, click on the CLOSE button to exit the dialog box.





## DISPLAY TROUBLESHOOTING

If you encounter problems with the display portion of the interactive pen display, refer to the following tables; your problem may be described here and you can try the solution offered. For additional information, refer to the documentation that came with your operating system or applications.

[General display problems](#)

[Pen tablet troubleshooting](#)

### GENERAL DISPLAY PROBLEMS

No display. Status LED is off.	<ul style="list-style-type: none"> <li>• Verify that the USB cable is connected to the pen display, and that the pen display is connected to your computer.</li> <li>• Verify that the Wacom tablet driver and DisplayLink or MCT driver were installed correctly. You can also download and install the DisplayLink driver from <a href="http://www.DisplayLink.com">www.DisplayLink.com</a>, and the MCT driver from <a href="http://www.wacom.com">www.wacom.com</a>.</li> </ul>
Status LED is not lit. A 'no signal go to power save' message appears briefly on your display screen.	<ul style="list-style-type: none"> <li>• Your computer may be in a power management mode. Touch the pen tip to the display screen, move the mouse, or depress any key on your keyboard.</li> <li>• Turn off both your computer and the pen display. Check the USB cable for bent or broken connector pins. Then properly connect the cable and turn on the pen display and your computer.</li> </ul>
When a still image is displayed for a long period of time without refreshing the screen, an after-image remains for a short period of time.	Use a screen saver or other power management feature.







## PEN TABLET TROUBLESHOOTING

If you encounter problems with the tablet portion of the interactive pen display, see the following tables. Your problem may be described here, and you can try the solution offered. For additional information, visit Wacom's web site at <http://www.wacom.com/support>.

### GENERAL PROBLEMS

The computer does not have an available USB port.	If a USB port is not available on your computer you will need to add a USB hub or USB card. However, Wacom recommends using USB ports on your computer instead of a USB hub whenever possible.
The pen works only in mouse mode, and does not draw or write with pressure sensitivity.	The driver software for the tablet portion of the pen display was not installed or did not load properly. Make sure the driver software is installed and functioning. Install the driver software in accordance with the instructions found in the <a href="#">installation</a> section of this manual.
The pen does not draw or write with pressure sensitivity.	Some applications require that you turn on the pressure capabilities within the application or selected tool before the pen will respond as a pressure-sensitive tool. Verify that your application supports pressure sensitivity.
Clicking is difficult.	Open the Wacom Control Panel and go to the PEN tab. Try using a lighter TIP FEEL.
The pen selects everything or will not stop sketching.	Open the Wacom Control Panel and go to the PEN tab. Move the TIP FEEL slider toward FIRM or select DETAILS... and increase the CLICK THRESHOLD setting. If this does not help, see <a href="#">testing your pen</a> .
Double-clicking is difficult.	Be sure you are quickly tapping the display screen twice in the same place on the pen display active area. Wacom recommends using the pen switch to double-click. Open the Wacom Control Panel and go to the PEN tab. Try increasing the TIP DOUBLE CLICK DISTANCE or using a lighter TIP FEEL. <u>Windows:</u> Try setting your system to launch programs with a single click. See <a href="#">clicking</a> .
You notice a delay at the beginning of pen or inking strokes.	Open the Wacom Control Panel and go to the PEN tab. Try decreasing the TIP DOUBLE CLICK DISTANCE. If that does not work, move the TIP DOUBLE CLICK DISTANCE slider to the OFF position in order to turn off double-click assist.
You have to press hard with the pen when clicking or writing.	Open the Wacom Control Panel and go to the PEN tab. Move the TIP FEEL slider toward SOFT, or select the DETAILS... button and decrease the SENSITIVITY and CLICK THRESHOLD settings.





The pen tip does not function.	<p>Make sure you are using the pen that originally came with your interactive pen display. Other pens may not function properly on the pen display.</p> <p>Check the Control Panel's PEN tab and verify that a CLICK function is assigned to the pen tip.</p> <p>Make sure the status LED lights blue when the tip is pressed. If the LED does not light, verify that the USB cable is plugged into an active port on your computer. If you are using only one USB connector to connect the pen display with your computer, plug in the other connector if you have an additional USB port available on your computer.</p> <p>If the LED still does not light, you may have defective hardware (see <a href="#">troubleshooting</a>).</p>
The pen tip and screen cursor do not properly line up.	Open the Wacom Control Panel and select the CALIBRATE tab. Continue with <a href="#">calibrating and adjusting the pen display</a> .
Changing the function settings for the pen has no effect.	Make sure you change the settings for the pen and application that you are using. See <a href="#">application-specific settings</a> .
The pen side switch does not work.	<p>Be sure you are using the pen that originally came with your pen display. Other pens may not function properly on the pen display.</p> <p>Be sure to press the switch when the pen tip is within 5 mm (0.2 inch) of the pen display active area. Do this without pressing down on the pen tip.</p> <p>In the Wacom Control Panel, verify that the switch is set to the proper function you are expecting to occur for the application and tool you are using.</p> <p>Check the SIDE SWITCH MODE. If CLICK &amp; TAP is selected, you will need to first press the switch, then touch the pen tip to the pen display screen surface in order to perform a click function.</p> <p>Make sure the status LED lights blue when you press the switch. If not, verify that the USB cable is plugged into an active USB port on your computer; the LED will not light if the USB cable is not plugged into an active port.</p> <p>If the LED does not light, you may have defective hardware (see <a href="#">troubleshooting</a>).</p>
The screen cursor moves but it does not jump to the pen tip location when the pen is placed on the display screen, and it does not follow the pen tip when the pen is moved across the display.	<p>Make sure the Wacom driver has loaded properly by opening the Wacom Control Panel. If the driver did not load you will see an error message. If an error message appears, reboot your computer. If the problem persists, refer to the <a href="#">installation</a> instructions and reinstall the Wacom driver software. (For Macintosh, you must restart your computer after installing the Wacom driver for proper operation.)</p> <p>If you have customized the switch on your pen to toggle between pen mode and mouse mode, make sure that your pen display is operating in pen mode.</p>





When using the pen display on a multiple monitor system, you cannot use the pen to control the other monitor(s).

Set the pen switch to [DISPLAY TOGGLE](#), then press the switch to cycle between pen control for the pen display and your other displays.

You can also use your pen to control the other monitors in mouse mode. To use mouse mode, first set the pen switch function to [MODE TOGGLE...](#) Then use the switch to toggle between pen mode and mouse mode.

The line you are sketching does not line up with the location of the screen cursor.

To function properly, some applications require that the pen is set to pen mode. Make sure the pen has not been toggled to mouse mode.

If the pen is set to pen mode and the problem still exists, then you may have a corrupted preferences file. Follow the instructions in the Windows or Macintosh troubleshooting sections to create a new preferences file.

The computer does not go to sleep.

When you are not using the pen, remove it from the pen display surface or the pen display will continue to send data, keeping the computer awake.

The screen cursor jumps back when using your regular mouse or trackball.

When the pen is not in use, place it in the pen storage compartment, or at some location near the pen display. Do not place it on the display. Leaving your pen on the display may interfere with screen cursor positioning when using other input devices.

The screen cursor moves erratically or jumps around on the display screen when another tablet is connected to your computer.

The tablet portion of the interactive pen display emits electromagnetic waves at a certain frequency. If another tablet is too closely placed to the unit it may interfere with screen cursor positioning. If this occurs, move the tablet further away from the pen display.





## WINDOWS-SPECIFIC PROBLEMS

You suspect the pen display preferences may be corrupted, or want to make certain that all settings are at their factory defaults.

Use the Wacom tablet Preference File Utility to work with your preferences.

Close any open applications.

Windows 8: From the Windows 8 Start screen, click the WACOM TABLET PREFERENCE FILE UTILITY tile. If you are using the Windows 8 Classic Desktop, press the Windows key on your keyboard, or select the Windows icon in the Charms bar, to access the Start screen.

Windows 7, Vista and XP: Open the utility by clicking the START icon and selecting ALL PROGRAMS. Select WACOM TABLET and WACOM TABLET PREFERENCE FILE UTILITY.

- It is a good idea to first back up your tablet preferences. In the TABLET PREFERENCE FILE UTILITY dialog box, click BACKUP... and follow the prompts.

- Then, delete the tablet preferences as follows:

Single user. In the TABLET PREFERENCE FILE UTILITY dialog box, click the REMOVE button under MY PREFERENCES to delete the preferences for the current user.

Multiple users. Click the REMOVE button under ALL USER PREFERENCES to delete preferences for multiple users. Note that administrator rights are required to delete preferences for all users. Relaunch any currently open tablet-aware applications that you may be running.

You can quickly restore tablet preferences that have been backed up by clicking RESTORE... under MY PREFERENCES.

---





## MACINTOSH-SPECIFIC PROBLEMS

At startup, a dialog box appears telling you that either the driver failed to load or the pen display preferences have not yet been created.

The tablet portion of the pen display was not detected at startup. Make sure the USB interface cable is securely connected to an active USB port on your computer. Make sure that the pen display LED is lit. If this does not correct the problem, see [troubleshooting](#).

From the GO menu, select the UTILITIES folder and launch the SYSTEM PROFILER. Select USB from the HARDWARE section of the CONTENTS list. A Wacom USB pen display model should be listed. If a pen display model is not listed, check the pen display USB cable connection or try plugging the pen display into a different USB port.

If this does not help, contact Wacom for Technical Support. See [technical support options](#).

You suspect the pen display preferences may be corrupted, or want to make certain that all settings are at their factory defaults.

Use the Wacom tablet Utility to work with your preferences. Close any open applications. Open the main APPLICATIONS folder. Then open the WACOM TABLET folder and run the WACOM TABLET UTILITY.

- It is a good idea to first back up your tablet preferences. In the WACOM TABLET UTILITY dialog box, select CURRENT USER or ALL USERS. Then click BACKUP... and follow the prompts.
- Then, delete the tablet preferences as follows:

Single user. When the utility starts, select CURRENT USER and click on the REMOVE button. Log out, then log back in. When the pen display driver loads it will create a new preferences file with the factory defaults.

Multiple users. When the utility starts, select ALL USERS and click on the REMOVE button. Log out, then log back in. When the pen display driver loads it will create new preferences files with the factory defaults.

You can quickly restore tablet preferences that have been backed up for the CURRENT USER or ALL USERS by clicking on the RESTORE... button within the utility.

**Note:** Do not manually remove the WACOM TABLET.PREFPANE file from the main LIBRARY PREFERENCEPANES folder. This file is only to be removed when uninstalling the Wacom software driver, and then only when using the WACOM TABLET UTILITY.

Recalibrate the pen display.





Ink does not work correctly with the pen display.

There may be a problem with the Ink preferences. Remove the damaged preference files as follows. They will be re-created when you enable handwriting recognition.

1. Open the SYSTEM PREFERENCES pane, choose SHOW ALL and select INK. Then turn off handwriting recognition.
2. From the GO menu, choose your HOME. Open the LIBRARY and PREFERENCES folders. Remove the following preferences:
  - COM.APPLE.INK.FRAMEWORK.PLIST
  - COM.APPLE.INK.INKPAD.PLIST
  - COM.APPLE.INK.INKPAD.SKETCH
3. Go back to SYSTEM PREFERENCES and INK, and then enable handwriting recognition.
4. Test the Ink function using your Wacom pen display and pen.

If this procedure does not resolve your problem with Ink, contact Apple Support for further assistance. Wacom is not the software manufacturer for Ink and we are limited in our abilities to support a third party software application.





## TECHNICAL SUPPORT OPTIONS

If you have a problem with your interactive pen display, first check the appropriate [installation](#) section in this guide to make sure the unit is installed correctly. Then review the [troubleshooting](#) procedures.

You can also check the product FAQs (Frequently Asked Questions) on the Wacom web site for your region, or request assistance through the Support or Customer Care area of the web site for your region.

If you have an Internet connection, you can download the latest software drivers from the Wacom web site for your region. See [obtaining driver downloads](#).

If you cannot solve the problem and you think your Wacom product is not working properly, contact the Wacom support staff for the region where your product was purchased, through the Support or Customer Care area of the web site for your region.

When you call, you should be at your computer with the following information available:

- This manual.
- Pen display serial number. (See the label on the back of the unit.)
- Driver version number. (See the Installation CD or click on the Wacom Control Panel ABOUT button.)
- The make and model of your computer, and operating system version number.
- A list of peripheral devices attached to your computer.
- The software application and version you were using when the problem occurred.
- The exact wording of any error message that appeared on your screen.
- What happened and what you were doing when the problem occurred.
- How you tried to solve the problem.





## OBTAINING DRIVER DOWNLOADS

Wacom periodically updates the software driver for the tablet portion of the interactive pen display to maintain compatibility with new products. If you are having a compatibility problem between your interactive pen display and a new hardware or software product, it may be helpful to download a new Wacom software driver (when available) from the Internet.

Updated drivers, when available, can be obtained from the Support page of the Wacom website for your region, <http://link.wacom.com/r/support>. The Support page also provides access to product information, manuals, Frequently Asked Questions (FAQ), and phone and email support.







## APPENDIX

This section contains tips on caring for your interactive pen display, instructions on how to uninstall the software, information on other Windows options for use on your pen display, and parts and accessories.

[Caring for the interactive pen display](#)

[Replacing the pen tip](#)

[Using an alternate mount or stand](#)

[Uninstalling the interactive pen display](#)

[Managing preferences](#)

[Installing multiple tablets](#)

[Pen and digital ink capabilities in Windows](#)

[About the Windows Tablet PC Input Panel](#)

[Product information](#)

[Ordering parts and accessories](#)

## CARING FOR THE INTERACTIVE PEN DISPLAY

Keep the pen and the LCD screen surface clean. Dust and dirt particles can stick to the pen and cause excessive wear to the display screen surface. Regular cleaning will help prolong the life of your LCD screen surface and pen.

Keep the pen display and pen in a clean, dry place and avoid extremes in temperature. Room temperature is best. The pen display and pen are not made to come apart. Taking apart the product will void your warranty.

**Important:** Take care to never spill liquids onto the pen display or pen. Be especially careful of getting the display, or pen buttons and tip wet as they contain sensitive electronic parts that will fail if liquids enter them.

To clean the pen display casing or the pen, use a soft, damp cloth; you can also dampen the cloth using a very mild soap diluted with water. Do not use paint thinner, benzine, alcohol, or other solvents to clean the unit casing or pen.

To clean the display screen, use an anti-static cloth or a slightly damp cloth. When cleaning, apply only a light amount of pressure to the display screen and do not make the surface wet. Do not use detergent to clean the display screen; this may damage the pen display screen. Please note that damage of this kind is not covered by the manufacturer's warranty.





## REPLACING THE PEN TIP

The pen tip (nib) will wear with normal use. Excessive pressure will cause it to wear sooner. If your pen display has a coated surface a worn nib may cause damage. To avoid this, periodic tip replacement is recommended.

When the nib gets too short or develops a sharp edge, replace it with one of the extra nibs that came with the pen.

Clasp the old nib with a Wacom nib extraction tool, pair of tweezers, needle-nosed pliers, or similar instrument and pull it straight out of the pen.

Slide the end of the new nib straight into the barrel of the pen. Firmly push the nib until it stops. The new nib will slide into the correct position.

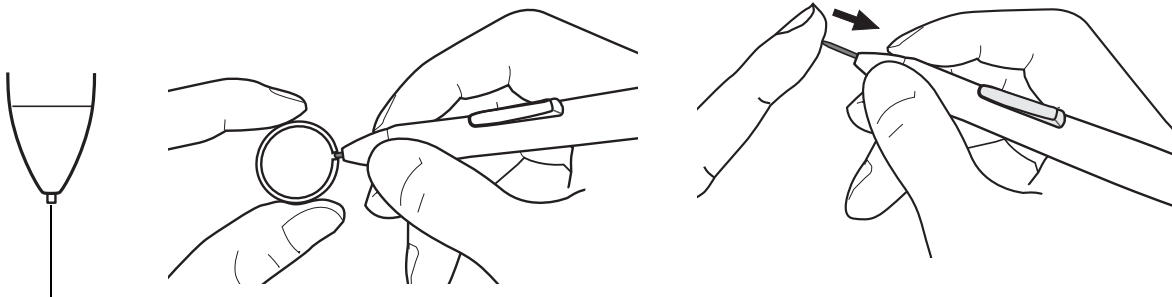

Replace the pen nib when it gets too short, or less than 1 mm (0.04 inch).

### Warning

Choking hazard. Prevent children from swallowing the pen nib or pen switch. The pen nib or switch may accidentally be pulled out if children are biting on them.

**Important:** When not in use, place the pen in the pen storage compartment or the pen stand, or lay it flat on your desk. Take care not to damage the pen nib when inserting or removing the pen from the storage compartment. To maintain the sensitivity of your pen, do not store the tool in such a way that it will rest on its tip.





## USING AN ALTERNATE MOUNT OR STAND

If you will be using the interactive pen display in an installation that requires the use of an alternate mounting platform, you can mount the pen display onto any mount arm or stand conforming to the VESA 75 mm standard.

### Caution

When attaching the pen display to an alternate mounting platform, be sure to follow all instructions in the documentation supplied by the platform manufacturer. If improperly installed, the unit could fall, resulting in damage to the unit or physical injury.

To attach the pen display to a different stand or mounting platform:

1. Turn off your computer.
2. Disconnect all cables from the pen display to your computer, and to alternate displays.
3. Protect the pen display screen surface by spreading a soft cloth onto a flat table and placing the pen display face down on the cloth.
4. Using the screws provided with the pen display, firmly attach the pen display to the alternate mounting platform. Refer to [Rear view](#) for the location of the VESA mounting holes.

Note: Wacom strongly recommends using the provided screws for attachment to an alternate arm or stand. However, if other mounting screws are used, they must match the provided screws in width, pitch and length, to avoid damage to the pen display or physical injury.





## UNINSTALLING THE INTERACTIVE PEN DISPLAY

Follow the appropriate procedure below to remove the Wacom driver software and the pen display from your system, or to remove the DisplayLink software from your system.

**Important:** If you remove the Wacom driver software from your system, your Wacom interactive pen display will no longer operate with full tablet functionality, but will continue to function as a mouse device.

### Windows 8:

1. From the Windows 8 Start screen, right-click in the screen's bottom left corner and chose CONTROL PANEL from the pop-up menu. If you are using the Windows 8 Classic Desktop, press the Windows key on your keyboard, or select the Windows icon in the Charms bar, to access the Start screen.
2. Choose UNINSTALL A PROGRAM or ADD OR REMOVE PROGRAMS.
3. Select WACOM TABLET and click on the REMOVE button.
  - To uninstall the DisplayLink or MCT driver, choose DisplayLink Core Software or the MCT program folder, and click on the Uninstall button.\

### Windows 7, Vista and XP:

1. Click START and choose CONTROL PANEL.
2. Click UNINSTALL A PROGRAM or ADD OR REMOVE PROGRAMS.
3. Select WACOM TABLET and click on the REMOVE button.
  - To uninstall the DisplayLink program, click on Add or Remove Programs, choose DisplayLink Core Software or the MCT program folder, and click on the Uninstall button.

Note: You may need to reboot your computer for the uninstall to take effect.

### Macintosh:

1. From the GO menu, choose APPLICATIONS and open the WACOM TABLET folder.
  - If you are removing the DisplayLink program, choose APPLICATIONS and open the DISPLAYLINK folder.
2. Double-click on the WACOM TABLET UTILITY icon and select the TABLET SOFTWARE: REMOVE button. Enter your administrator login name and password.
  - If you are removing the DisplayLink or MCT driver, double-click the DisplayLink Software Uninstaller or MCT Software Uninstaller icon, and click on the Uninstall button.
3. When the removal is completed, click OK.

Note: You may need to reboot your computer for the uninstall to take effect.





## MANAGING PREFERENCES

Use the Wacom tablet preferences utility to manage your pen display preferences for a single or multiple users.

Close any open applications.

Windows 8: From the Windows 8 Start screen, click the WACOM TABLET PREFERENCE FILE UTILITY tile. If you are using the Windows 8 Classic Desktop, press the Windows key on your keyboard, or select the Windows icon in the Charms bar, to access the Start screen.

Windows 7, Vista and XP:

1. Click the START icon and select ALL PROGRAMS.
2. Select WACOM and WACOM TABLET PREFERENCE FILE UTILITY.

Set your preferences in all Windows systems as follows:

- To remove preferences for the current user, click on the REMOVE button under MY PREFERENCES.
- To delete preferences for multiple users, click on the REMOVE button under ALL USER PREFERENCES. Administrator rights are required to delete preferences for all users. Relaunch any currently open tablet-aware applications that you may be running.
- To back up your preferences, click on the BACKUP... button under MY PREFERENCES.
- To restore preferences that you had previously backed up, click on the RESTORE... button under MY PREFERENCES.

Be sure to carefully follow any prompts that may appear.

Macintosh:

1. Open the main APPLICATIONS folder.
2. Open the WACOM TABLET folder and run the WACOM TABLET UTILITY.
  - To remove preferences, select CURRENT USER or ALL USERS. Then click on the REMOVE button. Log out, then log back in. When the software driver loads it will create a new preferences file with the factory defaults.
  - To back up your preferences, select CURRENT USER or ALL USERS. Then click on the BACKUP... button.
  - To restore preferences that you had previously backed up, select CURRENT USER or ALL USERS. Then click on the RESTORE... button.

Be sure to carefully follow any prompts that may appear.





## INSTALLING MULTIPLE TABLETS

The TABLET list displays an icon for any supported pen display or tablet that has been detected on your system, and allows you to select the pen display or tablet for which your changes will apply.

Select a pen display or tablet icon for which to customize pen and application settings.

- The Control Panel will not launch unless a supported pen display or tablet is connected to the computer.
- Settings can only be viewed or changed for an attached pen display or tablet.

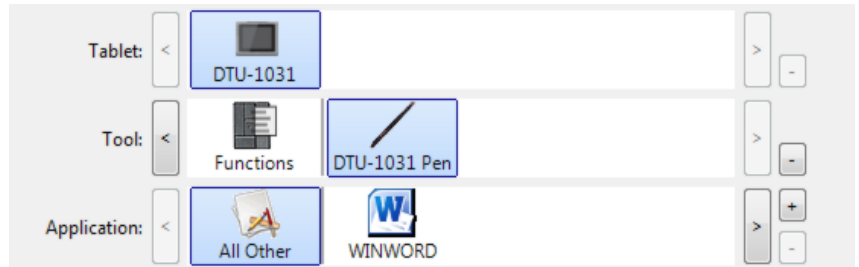

To add a new pen display or tablet, connect it to your computer. For USB products, the system searches the USB ports. When the new pen display or tablet is found, it is automatically initialized.

To remove one of multiple tablets from the driver, in the Wacom Control Panel select the pen display or tablet icon to be deleted and click on the [ - ] button next to the TABLET list.

- A pen display or tablet cannot be deleted from the Control Panel list unless it is attached to the computer.
- Note that you will need to restart your computer before you can again add the pen display or tablet to the driver.





## PEN AND DIGITAL INK CAPABILITIES IN WINDOWS

Microsoft Windows 8, Windows 7 and Vista provide extensive support for pen input\*. When using the interactive pen display with a computer running Windows 8, Windows 7 or Vista, your experience is enhanced by powerful note taking, handwriting recognition, fast navigation, and other digital inking options designed to give you quick, intuitive results with the Wacom pen.

To activate Windows Ink, click the Use Windows Ink checkbox on the Calibrate tab of the Wacom Control Panel.

- **Note taking.** Use your Wacom pen to jot notes and capture quick sketches in Windows Journal. Journal simulates a physical notebook, but with the advantages of digital note taking. You can choose from a variety of pen, marker, and highlighter tools. Journal also includes a powerful search engine that can even locate your handwritten content.
- **Handwriting recognition.** Because Windows includes powerful handwriting recognition capabilities, you can use your Wacom pen to quickly enter handwritten information anywhere the computer accepts typed input. You can convert your handwritten content to typed text at any time.
- **Gestures.** Use your Wacom pen to make simple gestural movements on the pen display to trigger customizable actions for navigation, editing, and other functions. To customize your gestures, select the FLICKS tab in the PEN AND INPUT DEVICES control panel.
- **Digital Ink in Microsoft Office 2007.** Use your Wacom pen to full advantage with the enhanced digital mark-up and inking tools available in Microsoft Office 2007 or later applications running on Windows 8, Windows 7 or Vista. Found on the REVIEW tab within applicable applications, these tools provide a consistent set of inking options. For quick access, you can add specific inking tools to the Quick Access Toolbar located at the top of each application.

To make the most of the pen in Microsoft Windows, refer to the documentation that came with your system, including the Windows training tools.

Note: The following workarounds in the software driver for the tablet portion of the pen display improve performance in Windows 8, Windows 7 and Vista:

- To improve performance, Pen Flicks and 'press-and-hold-to-right-click' features are disabled in some graphics applications.
- There is no pressure sensitivity in Journal and other Ink features when both the Flicks and 'press-and-hold-to-right-click' features are disabled in the Vista PEN AND INPUT DEVICES control panel.

\* Pen features are supported in all versions of Windows 8, Windows 7 and Vista except Windows Starter and Home Basic, and Windows Vista Home Basic.





## ABOUT THE WINDOWS TABLET PC INPUT PANEL

The Windows 8, Windows 7 or Vista Input Panel enables you to use handwriting or an on-screen keyboard to directly enter text with your Wacom pen. There are different ways to launch the Input Panel:

- Click on the Input Panel icon which appears when you move the screen cursor into a text entry area.
- Click on the Input Panel tab, located by default on the left edge of the display screen.
- Click on the Tablet PC Input Panel icon located on the Windows taskbar. If the icon is not visible, right-click on the taskbar, select **TOOLBARS**, and **TABLET PC INPUT PANEL**.

To customize the Input Panel:

1. First open the Input Panel and then click on **TOOLS** in the menu bar.
2. Select **OPTIONS** to open the Input Panel Options dialog box.
3. Customize the Input Panel settings for the way you like to work.

To learn more about using your Wacom pen in Microsoft Windows and Office 2007 or later, study the documentation that came with your system and Microsoft Office applications. Be sure to take advantage of the Windows training tools available from Microsoft.







## PRODUCT INFORMATION

To learn more about your interactive pen display and how to take full advantage of the many pen and [digital inking](#) features in Microsoft Windows, visit the Wacom web site for your region:

USA, Canada, Central and South America	<a href="http://www.wacom.com/products">http://www.wacom.com/products</a>
Europe, Middle East and Africa	<a href="http://www.wacom.eu">http://www.wacom.eu</a>
Japan	<a href="http://tablet.wacom.co.jp">http://tablet.wacom.co.jp</a>
Asia Pacific (English)	<a href="http://www.wacom.asia">http://www.wacom.asia</a>
China (Simplified Chinese)	<a href="http://www.wacom.com.cn">http://www.wacom.com.cn</a>
Korea	<a href="http://www.wacom.asia/kr">http://www.wacom.asia/kr</a>
Taiwan	<a href="http://www.wacom.asia/tw">http://www.wacom.asia/tw</a>
Thailand	<a href="http://www.wacom.asia/th">http://www.wacom.asia/th</a>

## ORDERING PARTS AND ACCESSORIES

For a list of available parts and accessories, visit the Wacom web site for your region.

To purchase parts and accessories in the USA or Canada, call 1.888.884.1870 (toll-free) or visit Wacom's web site at <http://www.wacom.com/store> (USA only).

To purchase parts and accessories in Europe, call +49 (0)180.500.03.75 or send an email to [spareparts@wacom.eu](mailto:spareparts@wacom.eu). Or, visit <http://shop.wacom.eu>. You can also contact your local dealer, distributor, or technical support using the appropriate number for your region.

To purchase parts and accessories in Australia, Singapore, Taiwan and Korea, please visit: [www.BuyWacom.com.au](http://www.BuyWacom.com.au), [www.BuyWacom.com.sg](http://www.BuyWacom.com.sg), [www.BuyWacom.com.tw](http://www.BuyWacom.com.tw) and [www.BuyWacom.co.kr](http://www.BuyWacom.co.kr), respectively.

To purchase parts and accessories in other countries, please contact your local dealer or distributor.

Please note that not all parts and accessories may be available in all regions.





## WARRANTY SERVICE IN THE U.S.A. AND CANADA

Warranty and licensing agreement is provided in the Important Product Information document that is included on your product CD.

To obtain Warranty service within the U.S. or Canada contact:

Wacom Customer Care Center

Phone: 1.360.896.9833

Email Inquiry form: <http://www.wacom.com/support/email.cfm>

## WARRANTY SERVICE OUTSIDE OF THE U.S.A. AND CANADA

For products purchased or used outside of the United States and Canada, the warranty period may be determined by regional requirements. The warranty period for your pen display is described on the Support page of the Wacom web site for your region. You may also contact Wacom Technical Support.

### Wacom Technical Support in Asia Pacific (except Japan and China)

Detailed Asia Pacific Limited Warranty policy and product registration may be found online at <http://www.wacom-asia.com>

To obtain technical support or Warranty service within Southeast Asia, Oceania and Taiwan, please contact the Wacom Customer Support Service.

Phone numbers can be found here: <http://www.wacom-asia.com/support/contact>

Should you have any questions about this Agreement, or if you desire to contact Wacom for any reason, please contact in writing:

#### IN NORTH AND SOUTH AMERICA CONTACT:

Wacom Technology Corporation  
1311 SE Cardinal Court  
Vancouver, Washington 98683  
U.S.A.

#### IN JAPAN CONTACT:

Wacom Co., Ltd.  
2-510-1 Toyonodai  
Otone-Machi, Kitasaitama-Gun  
Saitama, 349-1148  
Japan

#### IN ASIA PACIFIC CONTACT:

Wacom Co., Ltd.  
Asia Pacific Office  
Harmony Tower 18F, 1-32-2 Hon-Cho,  
Nakano-Ku, Tokyo 164-0012  
Japan

#### IN MAINLAND CHINA (EXCEPT HONG KONG) CONTACT:

Wacom China Corporation  
Unit 2807, 28th Floor, SK Tower  
No 6 Jia, Jianguomenwai Avenue,  
Beijing, 100022, China  
E-mail: [support@wacom.com.cn](mailto:support@wacom.com.cn)





## GLOSSARY

**Active area.** The area of the pen display where your pen is detected.

**Application-specific settings.** Pen display tool and tablet settings that have been customized for individual applications. The Wacom Control Panel enables you to customize the pen to behave uniquely in different applications. Your application-specific settings are in effect whenever you use the application. See also [application-specific settings](#).

**Aspect.** The ratio between the vertical and horizontal dimension of the active area on the pen display.

**Click force.** The amount of force you must apply to the tip of your pen for a click to occur.

**Double-click assist.** A function of the Wacom Control Panel that makes it easier to double-click by setting the size of the double-click distance.

**Double-click distance.** The maximum distance (in screen pixels) that the cursor can move between clicks and still be accepted as a double-click. Increasing the double-click distance makes double-clicking easier, but may cause a delay in brush strokes in some graphics applications.

**Double-click speed.** The maximum time that can pass between clicks and still be accepted as a double-click.

**Journal.** A Microsoft Windows application that electronically simulates a physical journal pad, but with the advantages of digital note taking. For example, you can create quick sketches and jot handwritten notes that can be converted to text and sent on to colleagues for digital mark-up. Journal includes a variety of pen, marker, and highlighter tools. Additionally, your handwritten content is searchable within Journal.

**Modifier.** Modifier keys include SHIFT, ALT, and CTRL for Windows, or SHIFT, CONTROL, COMMAND, and OPTION for Macintosh. You can customize your pen functions to simulate a modifier key.

**Mouse acceleration.** A setting that allows you to adjust the screen cursor acceleration when using mouse mode.

**Mouse mode.** A method for positioning the screen cursor. When you place the pen on the pen display, you can move the screen cursor with a “pick up and slide” motion similar to using a traditional mouse. This is known as relative positioning. See also [pen mode](#).

**Mouse speed.** A setting that allows you to adjust the speed at which your screen cursor moves when using mouse mode.

**Nib.** The replaceable pen tip.





**Pen mode.** A method of positioning the screen cursor. Wherever you place your pen on the interactive pen display, the screen cursor will jump to the corresponding point on the screen. This is known as absolute positioning, and is the default setting for the pen. Pen mode allows you to quickly position the screen cursor without having to first find it and then move it across the desktop. See also [mouse mode](#).

**Pixel.** The smallest unit of measure on your display screen.

**Pressure sensitive.** A quality of the Wacom pen tip that senses the amount of pressure being applied. This is used to create natural-looking pen and brush strokes in applications that are pressure sensitive.

**Pressure-sensitive application.** Any application that supports pressure-sensitive input.

**Proximity.** The height above the pen display active area where the pen is detected.

**Radial Menu.** A hierarchical menu (in radial format). Each level of the menu consists of eight menu slices which may contain various features and options to choose from. You can set the switch on your pen to display this menu.

**Screen cursor.** The pointer on the display screen. Screen cursors come in different shapes (such as an I-beam, arrow, or box), depending on which application you are running.

**Side switch.** The switch or button on the side of the DTU-1031 pen that can be used to execute various product functions.

**Tablet PC Input Panel (TIP).** The Microsoft Windows Tablet PC Input Panel enables you to use your Wacom pen to create handwritten notes or work with an on-screen keyboard. The Input Panel dynamically converts your handwriting to text. The information you create can then be inserted into other documents, spreadsheets, or illustrations.

**USB.** Universal Serial Bus. A hardware interface standard for connecting computer peripheral devices. USB ports support hot-plugging, which allows you to connect or disconnect a USB device without turning off your computer.





## INDEX

Accessories		Functions, button	28
ordering	57	General problems, troubleshooting	41
Application-specific settings	34	Holding the pen	16
changing	36	Incline, adjusting	9
creating	35	Information, product	57
removing	36	Installation	11
Button functions	28	for display portion	12
Calibrating, pen display	23	for pen tablet portion	13
Care, for pen display	49	USB cable	13
Cleaning		Installing	
pen	49	multiple pen displays	54
pen display	49	multiple tablets	54
Clicking, with pen	17	LCD monitor installation, for pen display	12
Control panel		Macintosh-specific problems, troubleshooting	45
lists	22	Manual	
opening	20	about	4
overview	21	navigating	5
tabs	22	Monitors, working with multiple	18
Customizing		Mount, using alternate	51
ExpressKeys	27	Multiple monitors, working with	18
pen	24	Navigating the manual	5
pen display	20	Ordering, parts and accessories	57
Digital ink, capabilities in Windows	55	Parts	
Display		ordering	57
problems, general	40	Pen	
troubleshooting	40	cleaning	49
Display Toggle, working with	33	clicking with	17
Double-click, adjusting	24	customizing	24
Downloads, obtaining driver	48	dragging with	17
Dragging, with pen	17	features	10
Driver downloads	48	holder	10
Eraser		holding	16
pressure setting, advanced	25	positioning with	16
Ergonomics	15	replacing tip	50
ExpressKeys		testing	39
using	19	tether	10
Features		using	16
pen	10	using side switch	18
pen display	7	working with pressure sensitivity	18
Front view, pen display	7		





Pen display		general problems	41
about	6	Macintosh-specific problems	45
adjusting		pen tablet portion	41
incline	9	Windows-specific problems	44
calibrating	23	Uninstalling	52
caring for	49	Using	
cleaning	49	ExpressKeys	19
customizing	20	Using, pen	16
features	7	Windows-specific problems	
front view	7	troubleshooting	44
installation	11	Working, with pen display	15
installing multiple units	54		
LCD monitor installation	12		
pen tablet installation	13		
rear view	8, 9		
testing	38		
uninstalling	52		
USB cable installation	13		
working with	15		
Pen tablet, troubleshooting	41		
Pen tip, replacing	50		
Positioning, with pen	16		
Preferences, managing	53		
Pressure sensitivity, working with	18		
Product information	57		
Radial Menu			
customizing	32		
using	32		
Rear view, pen display	8, 9		
Requirements, system	11		
Settings			
application-specific	34		
Side switch, using	18		
Stand, using alternate	51		
System requirements	11		
Tablet PC Input Panel, about	56		
Tablets, installing multiple	54		
Technical support, options	47		
Testing			
pen	39		
pen display	38		
Tip feel, adjusting	24		
Tip pressure setting, advanced	25		
Troubleshooting	37		
display	40		

