

PHU-111

Ⓔ Quick start guide

Ⓓ Schnellstartanleitung

Ⓒ Snelgids

Ⓕ Guide de mise en route

Ⓘ Guida rapida

Ⓔ Guía de arranque rápido

Ⓗ Guia de inicialização rápida

Ⓗ Podręcznik szybkiej instalacji

Ⓔ Руководство по быстрому запуску

Ⓙ クイックスタートガイド

Ⓚ 퀵 스타트 가이드

Ⓣ 快速入門指南

Ⓢ 快速入门指南



WACOM®

Supplied accessories

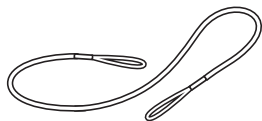

Pen tether

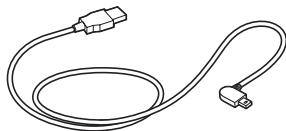

USB cable (3m)

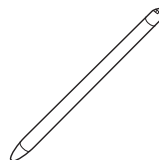

Pen

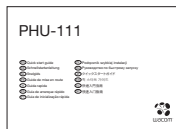

Quick start guide



Ink cartridge



Nib removal tool

Getting to know the product

1. Bluetooth status LED
2. Application status LED
3. Speaker
4. Battery status LED
5. Start / Finish button
6. Paper area
7. USB/BT mode selector

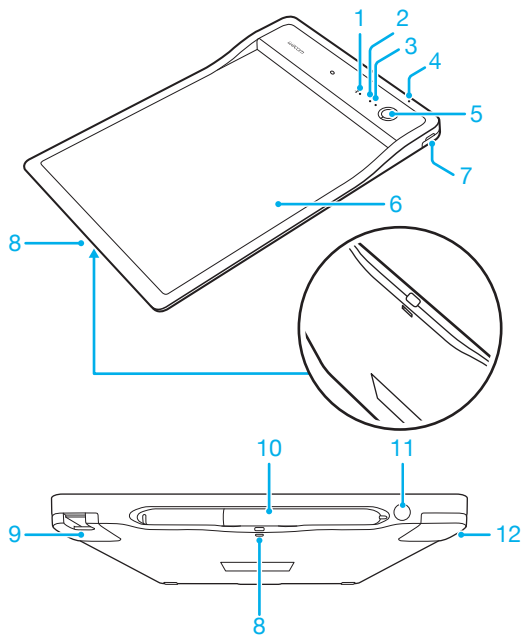

8. Pen tether hole
9. USB plug cover
10. Pen compartment
11. Power button
12. Charging contacts

LED indicator

1. Battery status LED (Orange)

Low battery	Blinking slowly
Charging	Blinking quickly
Battery full	On

2. Bluetooth status LED (Blue)

Pairing	Blinking
Paired	On

3. Application status LED (Green)

Ready	On
Not ready	Off

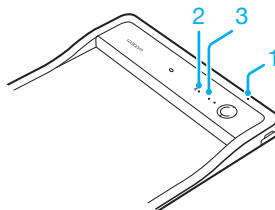

Pen storage compartment and pen tether

- Keep the pen in the compartment.

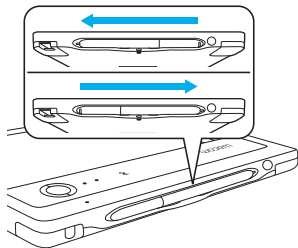

- Pen tether hole

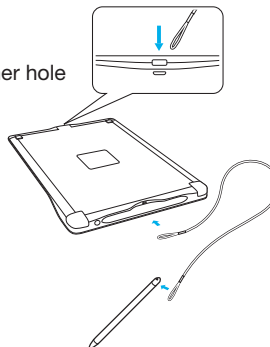

Getting started with your mobile device or PC

- Download the CLB Paper application to your mobile device or PC.

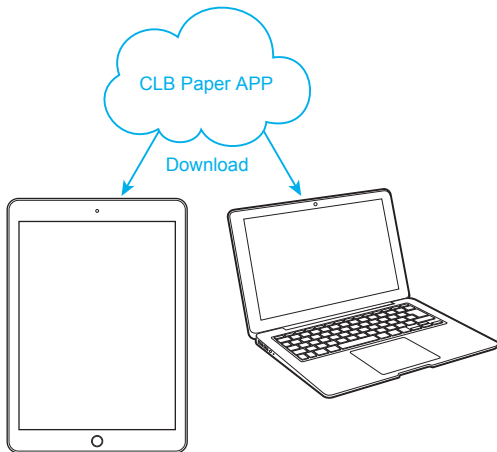

Bluetooth mode

1. Slide the switch to BT mode

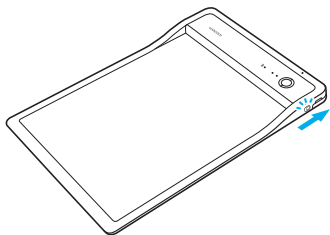

3. Press the power button to turn on the PHU-111

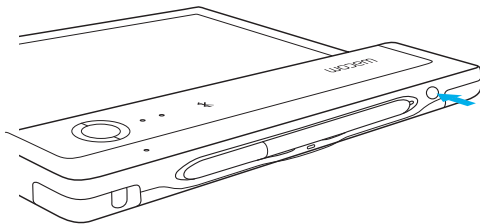

2. Charge the PHU-111 for at least 2 hours

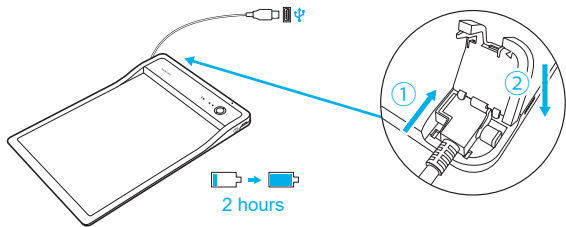

4. Open the CLB Paper application

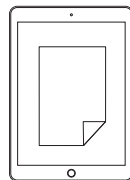

USB mode

1. Slide the switch to USB mode

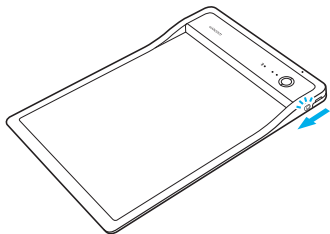

2. Connect the PHU-111 to a PC via USB

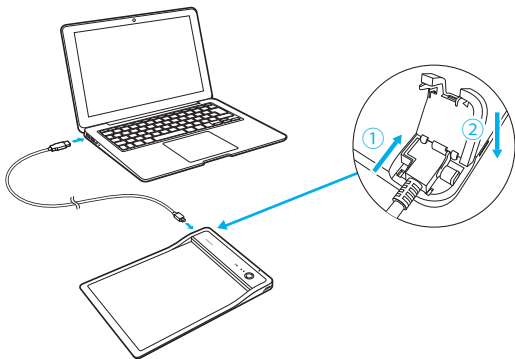

3. Open the CLB Paper application

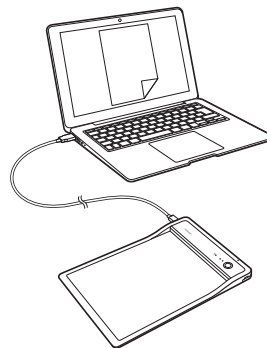

Getting started with CLB Paper

- Open the clip and insert your document

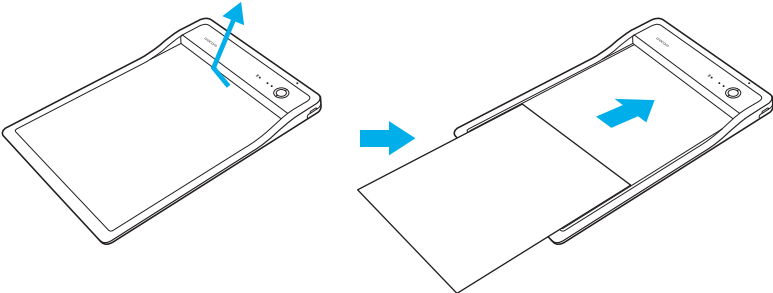

Align your document with the upper left corner of the PHU-111

- Confirm that the correct document appears on your mobile device or PC

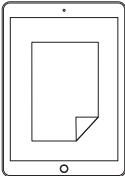

- Push the Start button to start the application
Begin writing when the application status LED is ON

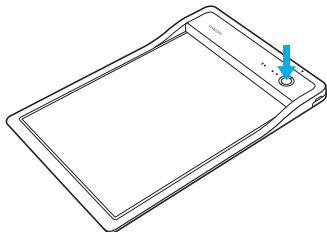

- When the document is completed, press the Finish button

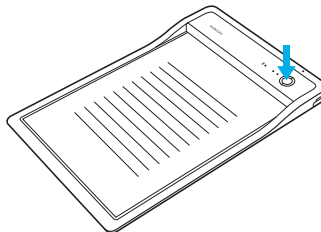

An alert will sound if you begin writing before the application is ready.

To get started with your Wacom Clipboard

<http://business.wacom.com/start>

Wacom Support / Wacom Customer Service

For support and to register your product, go to wacom.com and click on Support.

© 2017 Wacom Co., Ltd. All rights reserved.

Wacom and its logo are trademarks and/or registered trademarks of Wacom Co., Ltd.

Mitgeliefertes Zubehör

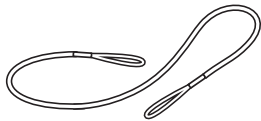

Stiftband

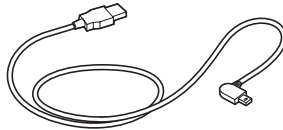

USB-Kabel (3m)

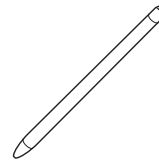

Stift

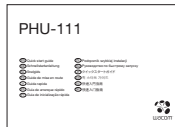

Schnellstartanleitung



Tintenpatrone



Werkzeug
zum Entfernen
der Stiftspitzen

Lernen Sie das Produkt kennen

1. LED für Bluetooth-Status
2. LED für Anwendungsstatus
3. Lautsprecher
4. LED zur Batteriestatus-anzeige
5. Start-/Beenden-Taste
6. Papierbereich
7. USB/BT-Modusauswahl
8. Öffnung zur Befestigung des Stiftbands
9. Abdeckung des USB-Anschlusses
10. Stiftfach
11. Netzschalter
12. Ladekontakte

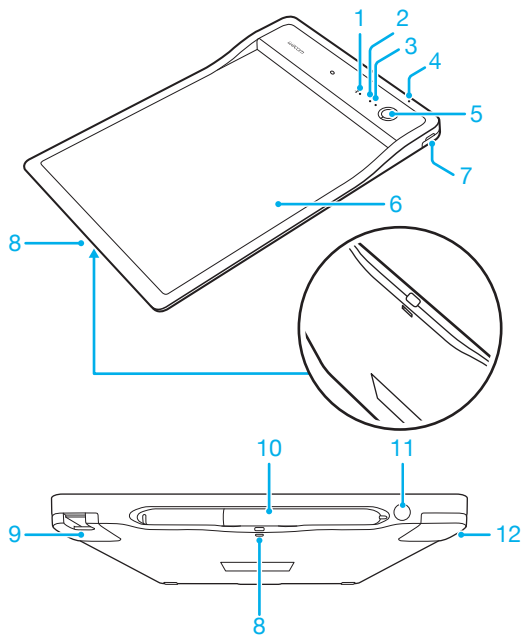

LED-Anzeige

1. LED zur Batteriestatusanzeige (Orange)

Niedriger Ladestand	Langsames Blinken
Laden	Schnelles Blinken
Batterie voll	An

2. LED für Bluetooth-Status (Blau)

Kopplung	Blinken
Verbunden	An

3. LED für Anwendungsstatus (Grün)

Bereit	An
Nicht bereit	Aus

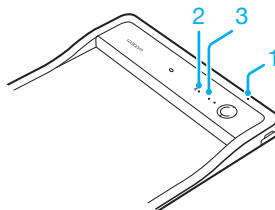

Stiftablagefach und Stiftband

- Bewahren Sie den Stift im Ablagefach auf.

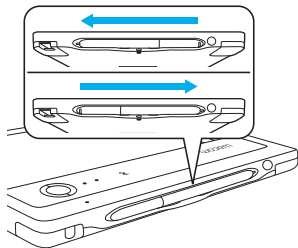

- Öffnung zur Befestigung des Stiftbands

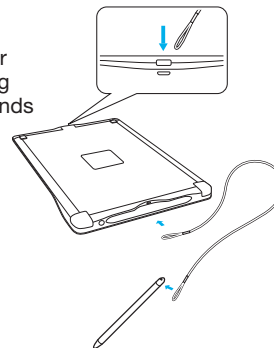

Erste Schritte mit Ihrem mobilen Endgerät oder PC

- Laden Sie die Anwendung CLB Paper auf Ihr mobiles Endgerät oder auf Ihren PC herunter.

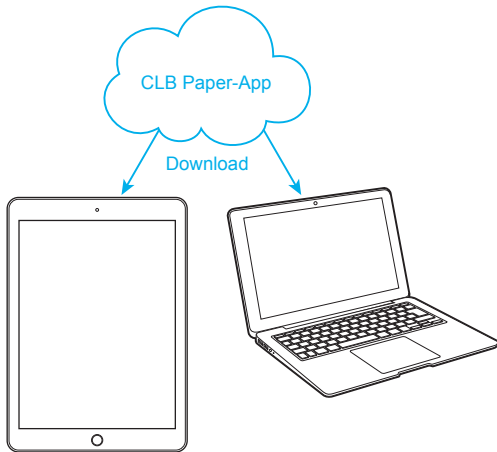

Bluetooth-Modus

1. Verschieben Sie den Schalter, um in den BT-Modus zu wechseln

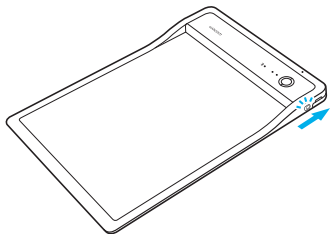

3. Drücken Sie den Netzschalter, um das PHU-111 einzuschalten

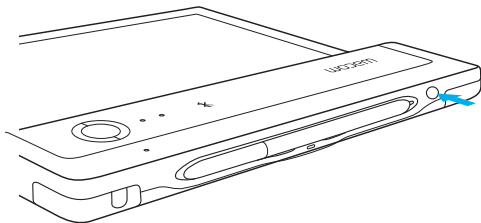

2. Laden Sie das PHU-111 mindestens 2 Stunden

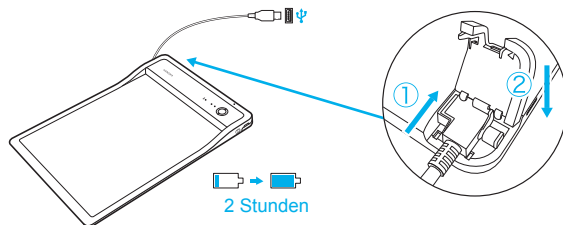

4. Öffnen Sie die Anwendung CLB Paper

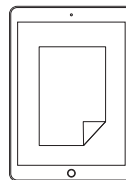

USB-Modus

DE

1. Verschieben Sie den Schalter, um in den USB-Modus zu wechseln

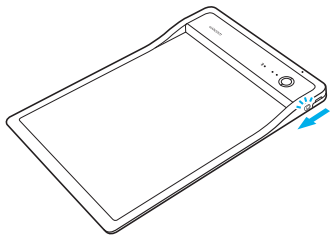

2. Verbinden Sie das PHU-111 per USB mit einem PC

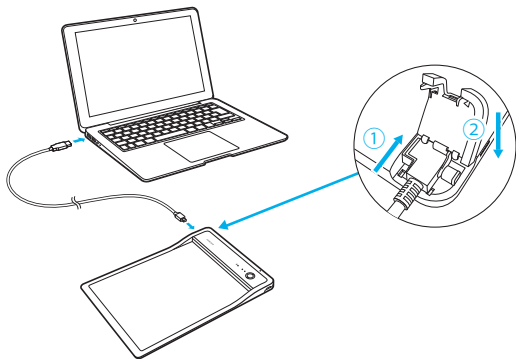

3. Öffnen Sie die Anwendung CLB Paper

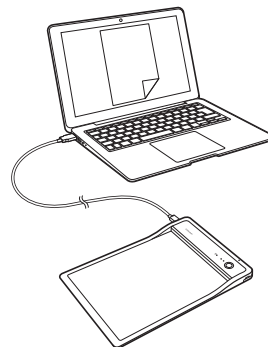

Erste Schritte mit CLB Paper

- Öffnen Sie die Klemme und führen Sie das Dokument ein

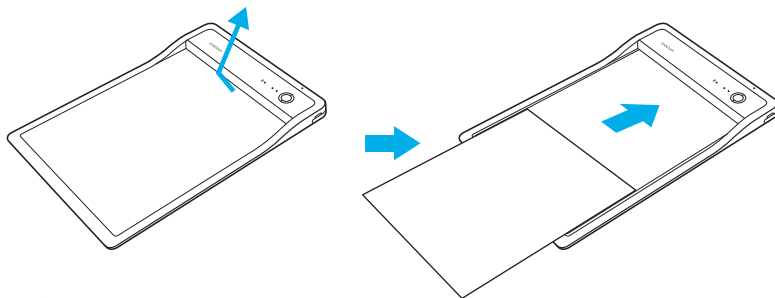

Richten Sie das Dokument an der oberen linken Ecke des PHU-111 aus

- Überprüfen Sie, ob das richtige Dokument auf Ihrem mobilen Endgerät oder PC erscheint

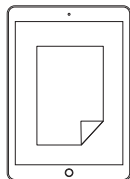

- Drücken Sie die Start-Taste, um die Anwendung zu starten
Beginnen Sie zu schreiben, wenn die LED für den Anwendungsstatus leuchtet

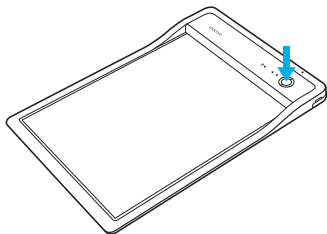

- Wenn das Dokument fertig ist, drücken Sie die Beenden-Taste

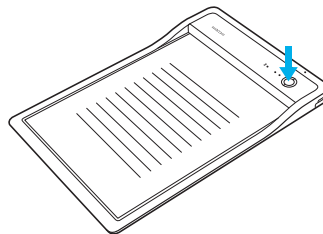

Es ertönt ein Alarm, wenn Sie zu schreiben beginnen, obwohl die Anwendung noch nicht bereit ist.

Erste Schritte mit Ihrem Wacom Clipboard

<http://business.wacom.com/start>

Wacom Support / Wacom Kundendienst

Informationen zum technischen Kundendienst und zur Produktregistrierung finden Sie auf wacom.com unter „Support“.

© 2017 Wacom Co., Ltd. Alle Rechte vorbehalten.

Wacom und das Wacom Logo sind Marken und/oder eingetragene Marken von Wacom Co., Ltd.

Meegeleverde accessoires

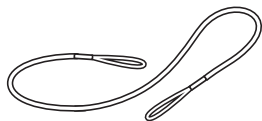

Pensnoer

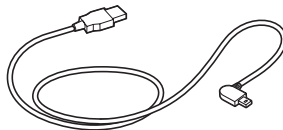

USB-kabel (3 m)

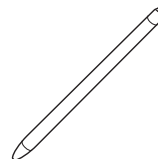

Pen

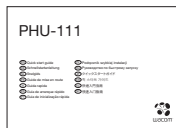

Snelgids



Inkcartridge



Penpuntverwijderaar

Kennismaken met het product

NL

1. Bluetooth status-LED
2. Toepassing status-LED
3. Luidspreker
4. Led voor batterijstatus
5. Start/finish-knop
6. Papiergebied
7. Keuze USB/BT-modus

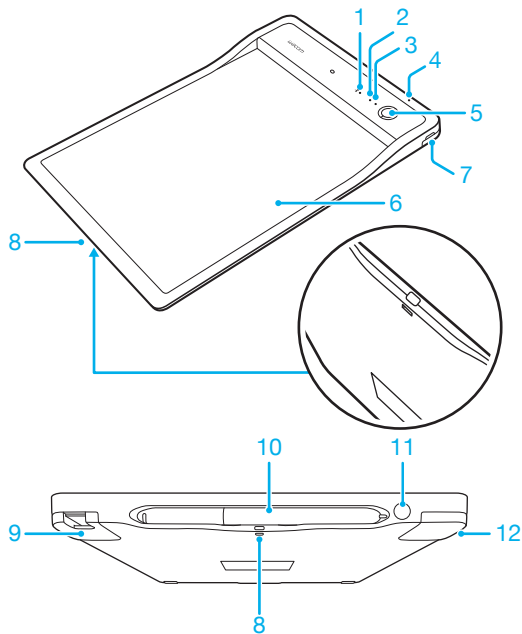

8. Pensnoeropening
9. Afdekking USB-poort
10. Pencompartiment
11. Aan/uit-knop
12. Laadcontactpunten

LED-indicator

1. LED voor batterijstatus (oranje)

Bijna leeg	Knippert langzaam
Opladen	Knippert snel
Batterij vol	Aan

2. Bluetooth status-LED (blauw)

Koppelen	Knippert
Gekoppeld	Aan

3. Toepassing status-LED (groen)

Klaar	Aan
Niet klaar	Off (Uit)

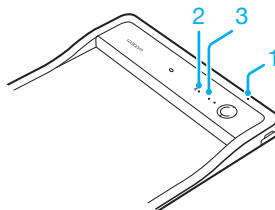

Opbergvak voor pen en pensnoer

- Bewaar de pen in het opbergvak.

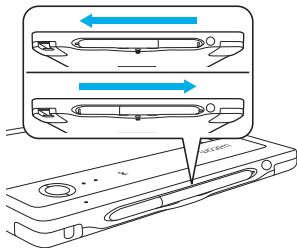

- Pensnoeropening

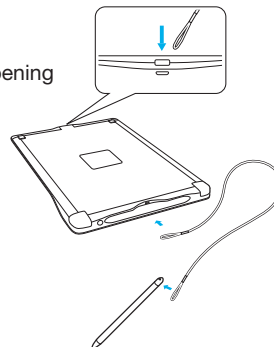

Aan de slag met uw mobiele apparaat of PC

- Download de CLB Paper-app op uw mobiele apparaat of PC.

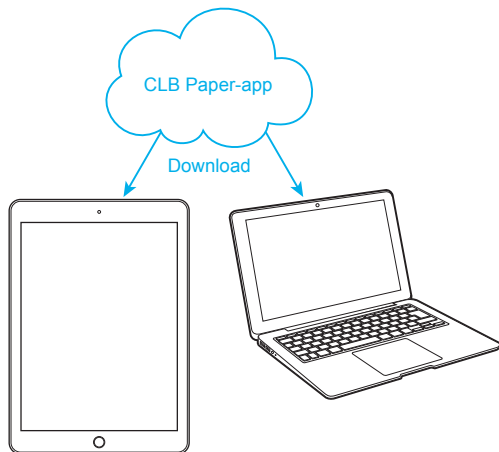

Bluetooth-modus

1. Zet de schakelaar in BT-modus

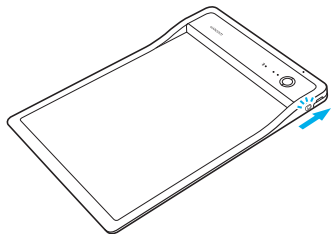

3. Druk op de aan/uit-knop om de PHU-111 in te schakelen

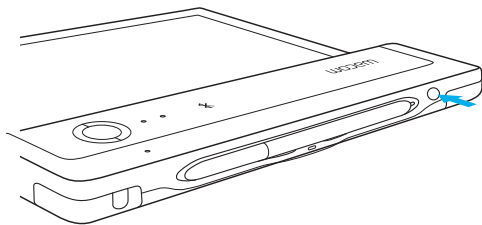

2. Laad de PHU-111 ten minste 2 uur

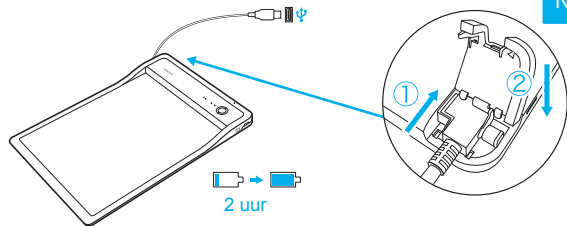

4. Open de CLB Paper-app

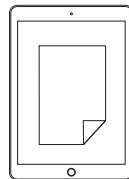

USB-modus

1. Zet de schakelaar in USB-modus

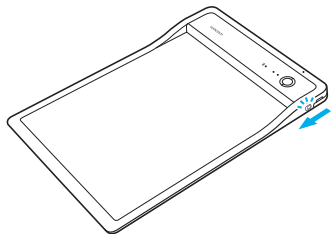

2. Sluit de PHU-111 via USB op een PC aan

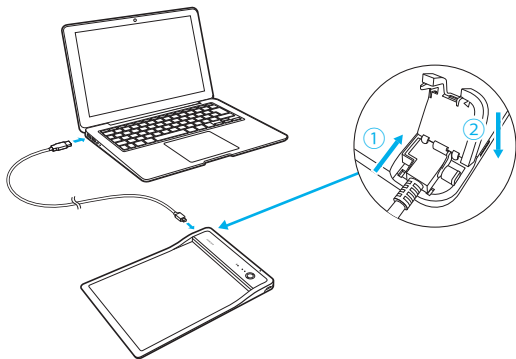

3. Open de CLB Paper-app

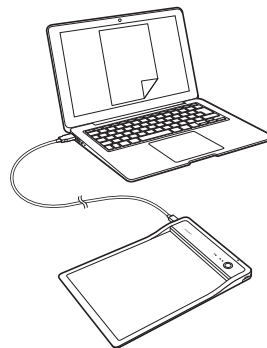

Aan de slag met CLB Paper

- Open de clip en plaats uw document

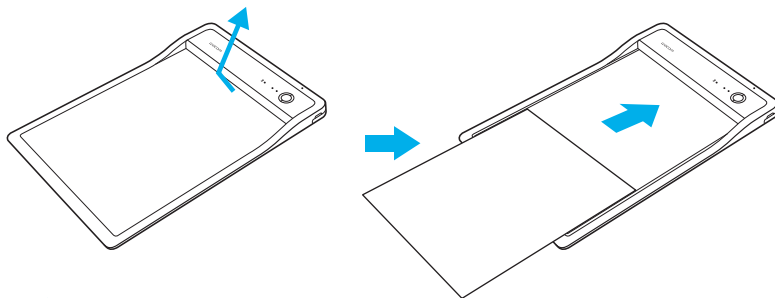

Lijn uw document uit met de linker bovenhoek van de PHU-111

- Bevestig dat het juiste document op uw mobiele apparaat of PC verschijnt

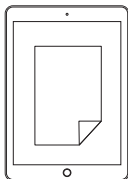

- Druk op de Start-knop om de toepassing te starten
Begin met schrijven zodra de status-LED toepassing brandt

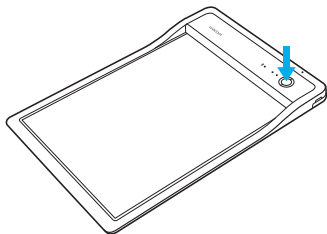

- Druk op de Finish-knop als het document klaar is

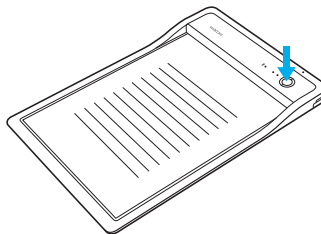

Er klinkt een waarschuwingssignaal als u begint te schrijven voordat de toepassing klaar is.

Aan de slag met uw Wacom Clipboard

<http://business.wacom.com/start>

Wacom Support / Wacom Customer Service

Ga voor technische ondersteuning en voor het registreren van uw product naar wacom.com en klik op "Support" (Ondersteuning).

© 2017 Wacom Co., Ltd. Alle rechten voorbehouden.

Wacom en diens logo zijn handelsmerken en/of gedeponeerde handelsmerken van Wacom Co., Ltd.

Accessoires fournis

FR

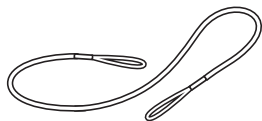

Cordon d'attache

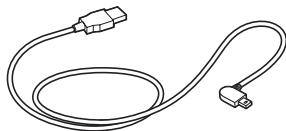

Câble USB (3 m)

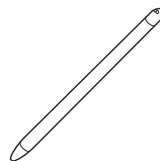

Stylet

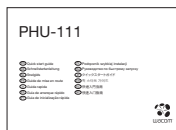

Guide de mise en route



Cartouche d'encre



Extracteur de pointe

Familiarisation avec le produit

FR

1. Voyant d'état Bluetooth
2. Voyant d'état application
3. Haut-parleur
4. Voyant d'état de la batterie
5. Bouton Démarrer / Terminer
6. Zone de papier
7. Sélecteur de mode USB/BT
8. Orifice de l'amarre-stylet
9. Cache de port USB
10. Range-stylet
11. Bouton d'alimentation
12. Contacts de la batterie

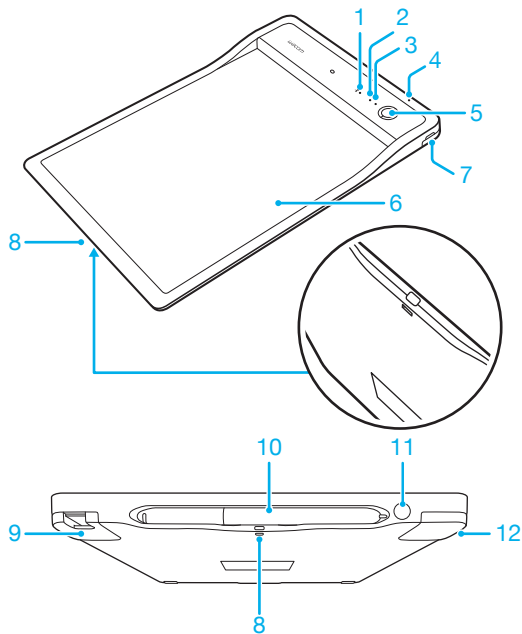

Voyant

1. Voyant d'état de la batterie (orange)

Faible charge	Clignote lentement
Charge	Clignote rapidement
Batterie pleine	Activé

2. Voyant d'état Bluetooth (bleu)

Jumelage	Clignote
Jumelé	Activé

3. Voyant d'état application (vert)

Prête	Activé
Pas prête	Désactivé(e)

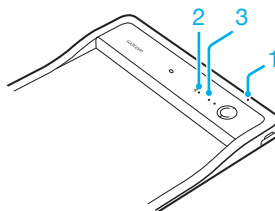

Range-stylet et cordon d'attache

- Conserver le stylet dans le range-stylet.

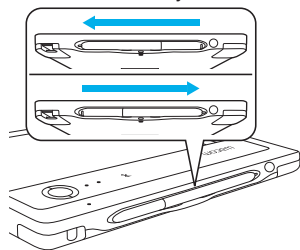

- Orifice de l'amarre-stylet

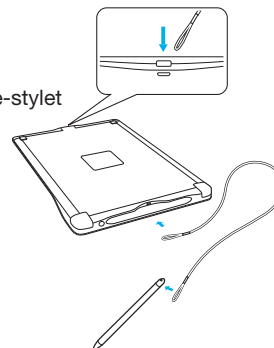

Mise en route de votre appareil mobile ou PC

- Télécharger l'application CLB Paper sur votre appareil mobile ou votre PC.

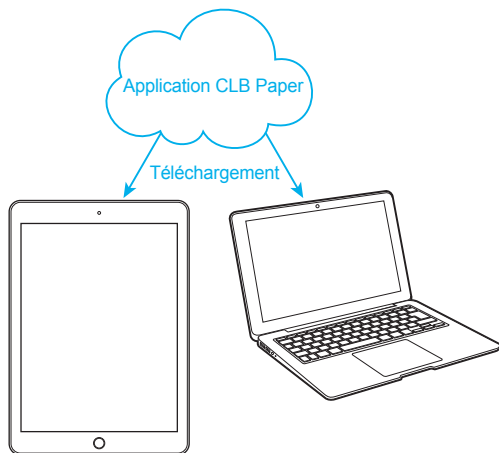

Mode Bluetooth

1. Glisser l'interrupteur en mode BT

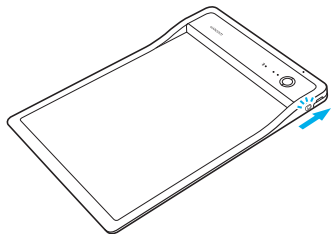

3. Appuyer sur le bouton d'alimentation pour allumer le PHU-111

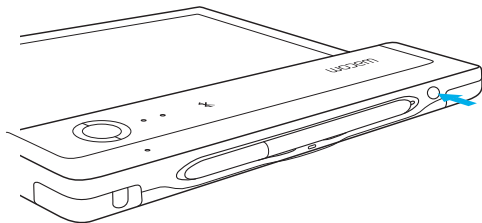

2. Charger le PHU-111 pendant au moins 2 heures

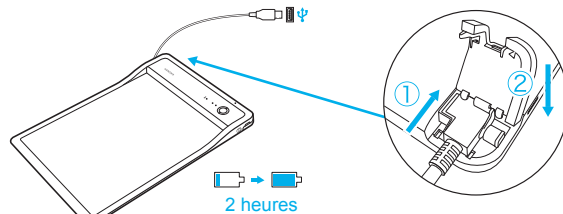

4. Ouvrir l'application CLB Paper

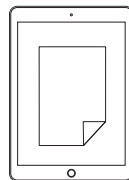

Mode USB

1. Glisser l'interrupteur en mode USB

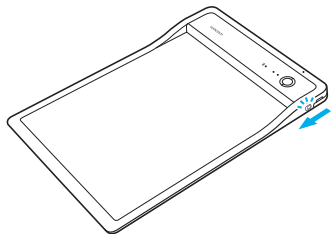

2. Connecter le PHU-111 à un PC via USB

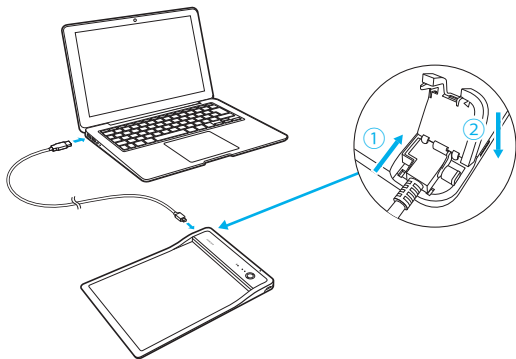

3. Ouvrir l'application CLB Paper

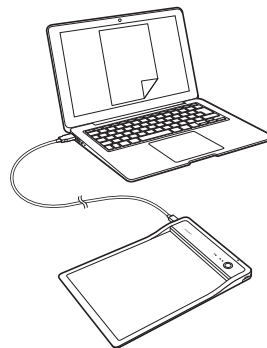

Mise en route avec CLB Paper

- Ouvrir le clip et insérer votre document

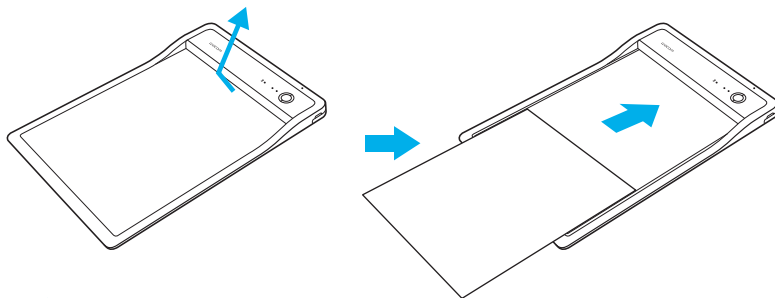

Aligner votre document avec le coin supérieur gauche du PHU-111

- Vérifier que le bon document s'affiche sur votre appareil mobile ou votre PC

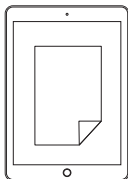

- Appuyer sur le bouton Démarrer pour lancer l'application
Commencer à écrire lorsque le voyant d'état de l'application est ACTIVÉ

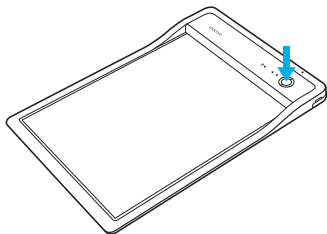

- Une fois le document achevé, appuyer sur le bouton Terminer

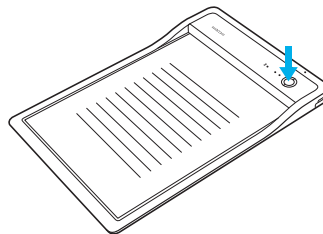

Une alerte sonore sera émise si vous commencez à écrire avant que l'application soit prête.

Vous familiariser avec votre Wacom Clipboard

<http://business.wacom.com/start>

Assistance Wacom / Service clientèle Wacom

Pour contacter l'assistance et enregistrer votre produit, rendez-vous sur wacom.com et cliquez sur « Aide » (assistance).

© 2017 Wacom Co., Ltd. Tous droits réservés.

Wacom et son logo sont des marques commerciales et/ou des marques déposées de Wacom Co., Ltd.

Accessori forniti in dotazione



Laccio anticaduta
(per la penna)

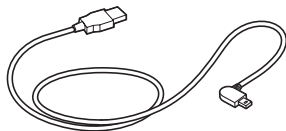

Cavo USB (3m)

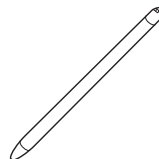

Penna

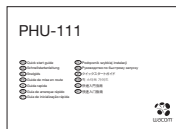

Guida rapida



Cartuccia a inchiostro



Accessorio per
estrarre la punta

Descrizione del prodotto

1. LED di stato Bluetooth
2. LED di stato applicazione
3. Altoparlante
4. LED di stato della batteria
5. Pulsante Avvio / Fine
6. Area carta
7. Selettore modalità USB/BT

8. Foro del laccio anticaduta della penna

9. Protezione spina USB

10. Astuccio della penna

11. Pulsante di accensione

12. Contatti di ricarica

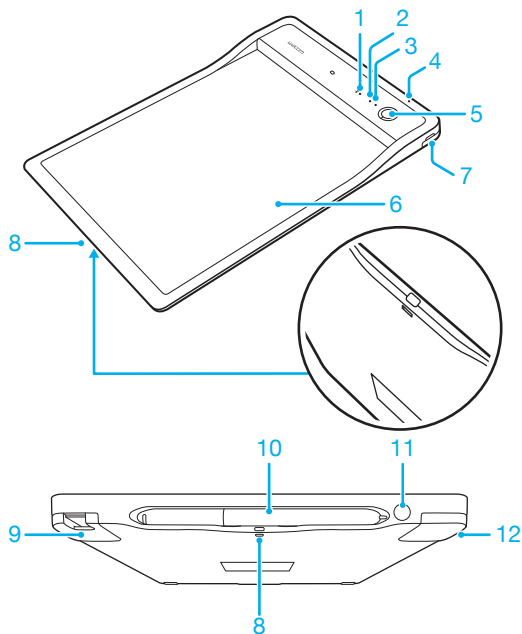

Indicatore a LED

1. LED di stato batteria (arancione)

Batteria quasi esaurita	Lampeggiante lentamente
Ricarica	Lampeggiante rapidamente
Batteria carica	Acceso

2. LED di stato Bluetooth (Blu)

Associazione	Lampeggiante
Associazione completata	Acceso

3. LED di stato applicazione (Verde)

Pronto	Acceso
Non pronto	Spento

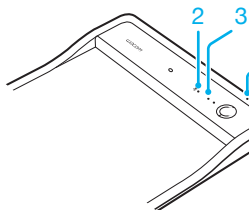

Astuccio per la penna e laccio anticaduta

- Conservare la penna nell'apposito astuccio.

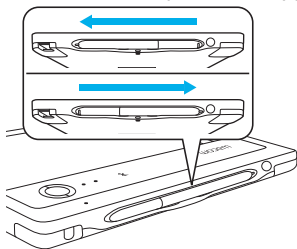

- Foro del laccio anticaduta della penna

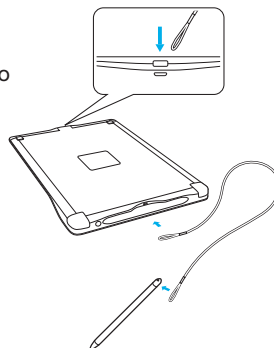

Introduzione all'uso con il proprio dispositivo mobile o PC

- Scaricare l'applicazione CLB Paper sul proprio dispositivo mobile o PC.

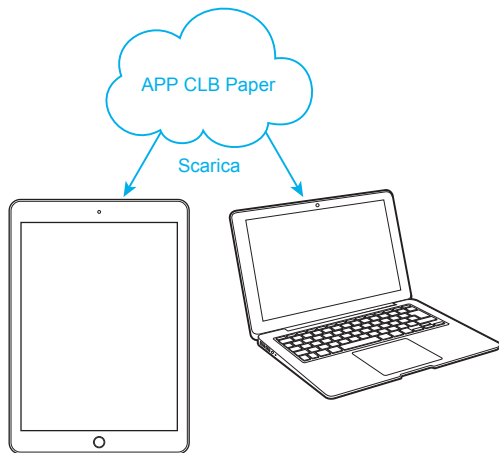

Modalità Bluetooth

1. Fare scorrere l'interruttore sulla modalità BT

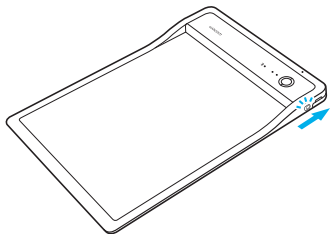

2. Caricare il PHU-111 per almeno 2 ore

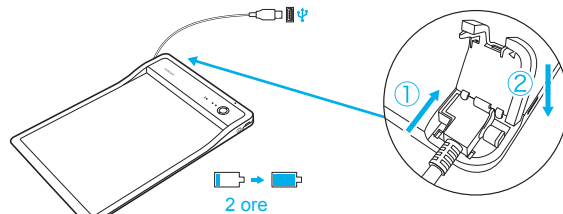

3. Premere il pulsante di accensione per attivare il PHU-111

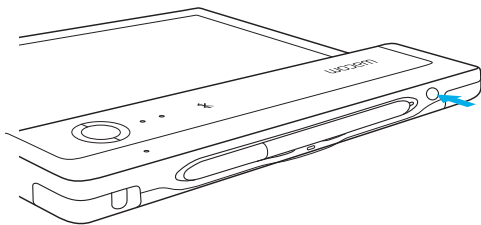

4. Aprire l'applicazione CLB Paper

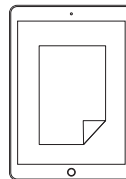

Modalità USB

1. Far scorrere l'interruttore sulla modalità USB

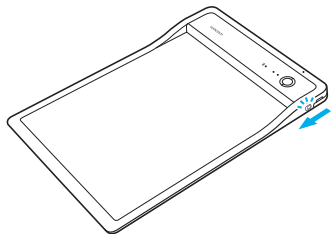

2. Collegare il PHU-111 a un PC tramite USB

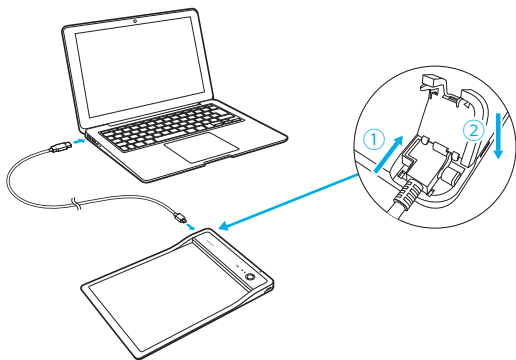

3. Aprire l'applicazione CLB Paper

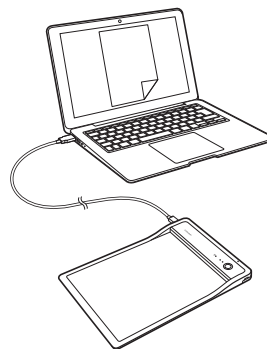

Introduzione all'uso di CLB Paper

- Aprire la clip e inserire i documenti

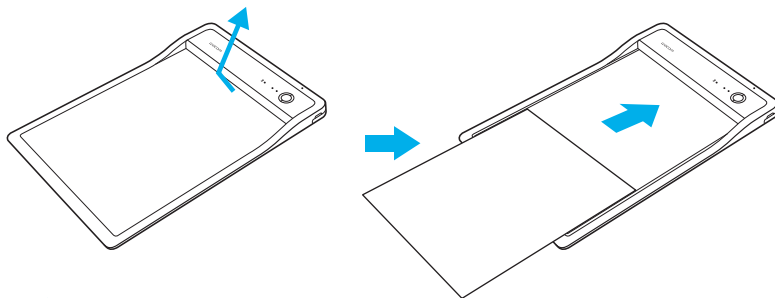

Allineare i documenti con l'angolo in alto a sinistra del PHU-111

- Verificare che il documento corretto sia visualizzato sul dispositivo mobile o PC

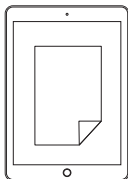

- Premere il pulsante Avvio per avviare l'applicazione
Iniziare a scrivere quando il LED di stato dell'applicazione è acceso
- Quando il documento è completo, premere il pulsante Fine

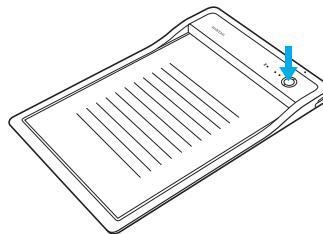
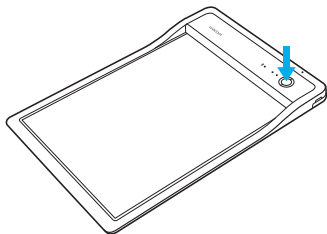

Se si inizia a scrivere prima che l'applicazione sia pronta, sarà emesso un avviso sonoro.

Procedure iniziali per l'utilizzo di Wacom Clipboard

<http://business.wacom.com/start>

Supporto Wacom / Servizio clienti Wacom

Per ricevere assistenza tecnica e registrare il prodotto, accedere a wacom.com e fare clic su Supporto.

© 2017 Wacom Co., Ltd. Tutti i diritti riservati.

Wacom e il relativo logo sono marchi e/o marchi registrati di Wacom Co., Ltd.

Accesorios incluidos



Cordón de sujeción

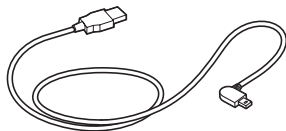

Cable USB (3 m)



Lápiz

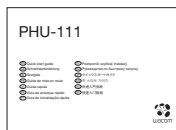

Guía de arranque rápido



Cartucho de tinta



Herramienta para extraer las puntas

Aspectos básicos del producto

1. LED de estado de Bluetooth
2. LED de estado de la aplicación
3. Altavoz
4. LED de estado de la batería
5. Botón de inicio/fin
6. Área para el papel
7. Selector de modo USB/BT
8. Orificio para la sujeción para lápiz
9. Cubierta del conector USB
10. Compartimento del lápiz
11. Botón de encendido
12. Contactos de carga

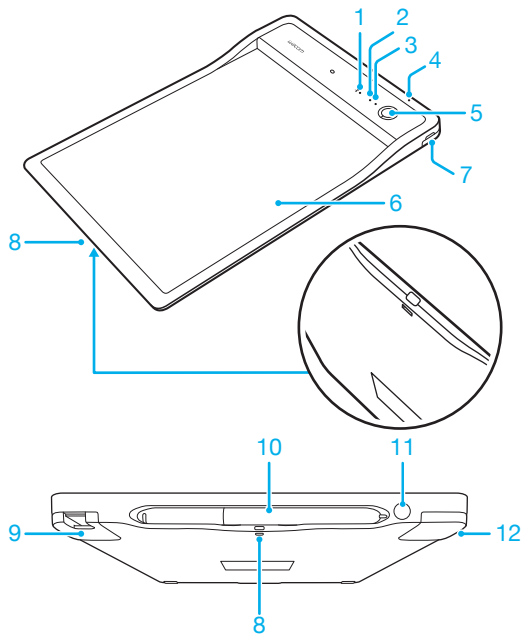

Indicador LED

1. LED de estado de la batería (naranja)

Batería baja	Intermitente lento
Cargando	Intermitente rápido
Batería totalmente cargada	Activado

2. LED de estado de Bluetooth (azul)

Emparejamiento	Intermitente
Emparejado	Activado

3. LED de estado de la aplicación (verde)

Preparada	Activado
No preparada	Desactivado

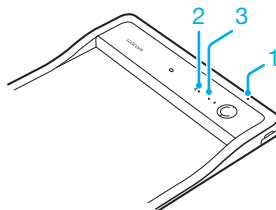

Compartimento para lápiz y cordón de sujeción

- Guarde el lápiz en el compartimento.

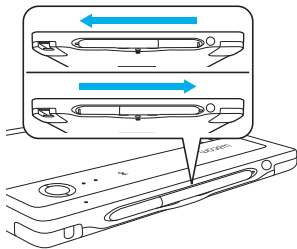

- Orificio para la sujeción para lápiz

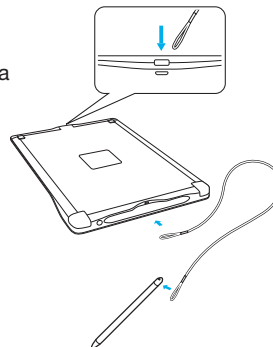

Preparación del dispositivo móvil o PC

- Descargue la aplicación CLB Paper en su dispositivo móvil o PC.

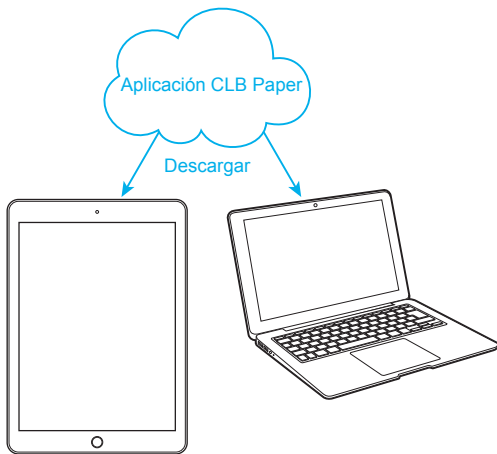

Modo Bluetooth

1. Deslice el interruptor al modo BT

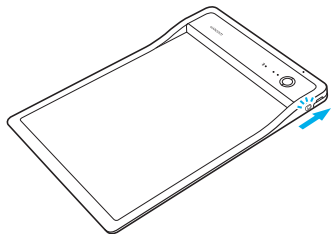

2. Cargue la PHU-111 durante 2 horas como mínimo

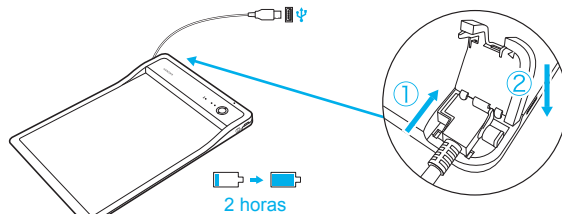

3. Pulse el botón de encendido para encender la PHU-111

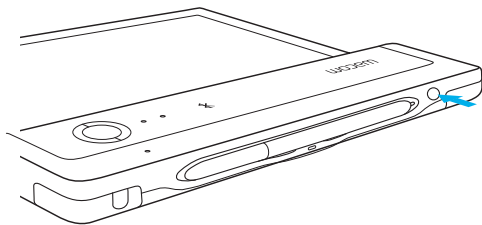

4. Abra la aplicación CLB Paper

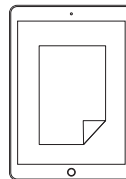

Modo USB

1. Deslice el interruptor al modo USB

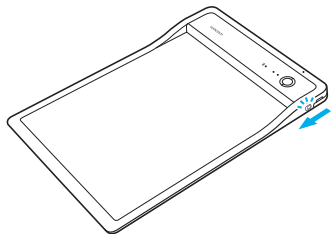

2. Conecte la PHU-111 a un PC mediante USB

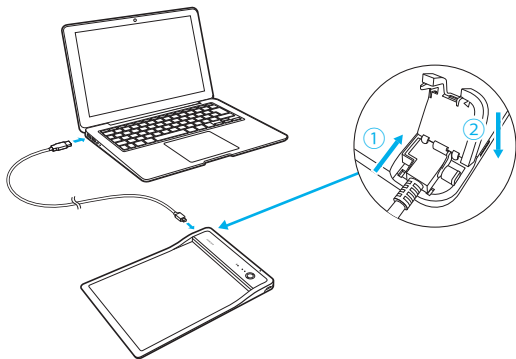

3. Abra la aplicación CLB Paper

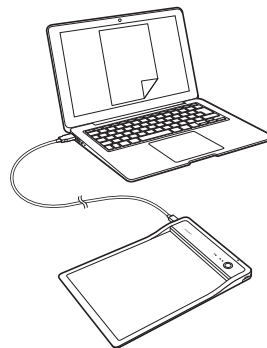

Primeros pasos con CLB Paper

- Abra el clip e inserte el documento

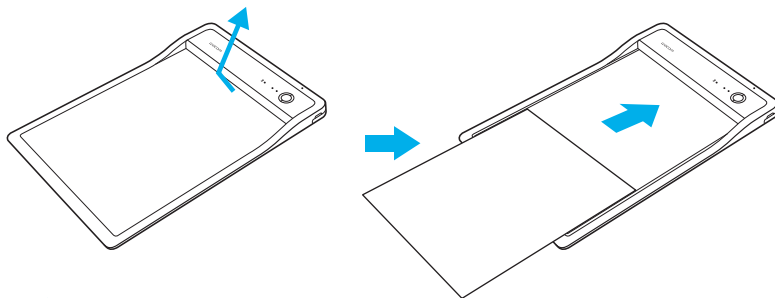

Alinee el documento con la esquina superior izquierda de la PHU-111

- Confirme que en el dispositivo móvil o PC aparece el documento correcto

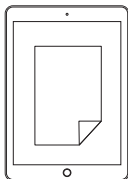

- Pulse el botón de inicio para iniciar la aplicación
Comience a escribir cuando se encienda el LED de estado de la aplicación

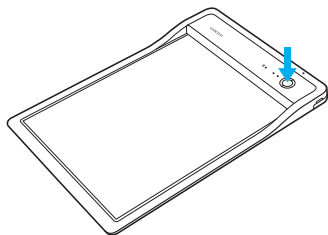

- Cuando haya terminado el documento, pulse el botón de finalizar

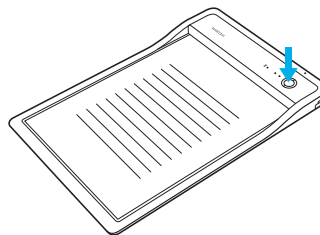

Sonará un aviso si comienza a escribir antes de que la aplicación esté lista.

Para comenzar a utilizar su Wacom Clipboard

<http://business.wacom.com/start>

Asistencia técnica de Wacom / Servicio al cliente de Wacom

Para recibir asistencia técnica y para registrar su producto, visite wacom.com y haga clic en Soporte.

© 2017 Wacom Co., Ltd. Todos los derechos reservados.

Wacom y su logotipo son marcas comerciales o marcas comerciales registradas de Wacom Co., Ltd.

Acessórios fornecidos



Cabo de fixação da caneta

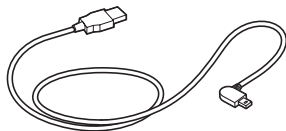

Cabo USB (3 m)

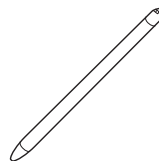

Caneta

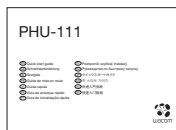

Guia de inicialização rápida



Cartucho de tinta



Removedor de ponta

Componentes do produto

1. LED de status do Bluetooth
2. LED de status do aplicativo
3. Alto-falante
4. LED de status da bateria
5. Botão Iniciar / Concluir
6. Área do papel
7. Seletor do modo USB/BT
8. Orifício do cabo de fixação para a caneta
9. Tampa do conector USB
10. Compartimento da caneta
11. Botão liga/desliga
12. Contatos do carregador

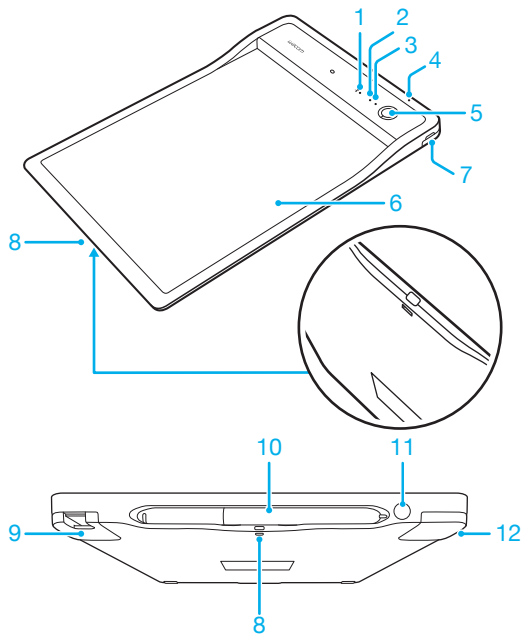

LED indicador

1. LED de status da bateria (laranja)

Bateria fraca	Pisca lentamente
Carregando	Pisca rapidamente
Bateria cheia	Ligado

2. LED de status do Bluetooth (Azul)

Emparelhamento	Piscando
Emparelhado	Ligado

3. LED de status do aplicativo (Verde)

Pronto	Ligado
Não está pronto	Desligado

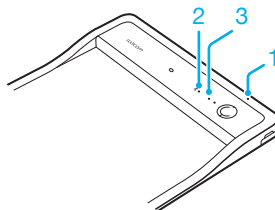

Compartimento para caneta e cabo de fixação

- Mantenha a caneta no compartimento.

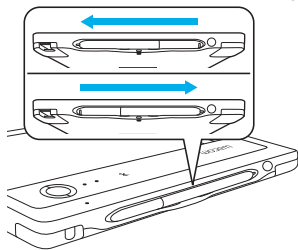

- Orifício do cabo de fixação para a caneta

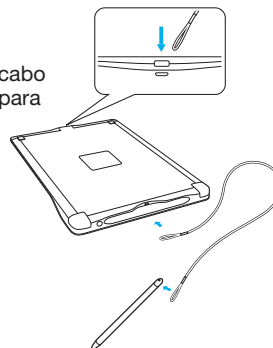

Guia de primeiros passos com seu dispositivo móvel ou PC

- Baixe o aplicativo CLB Paper em seu dispositivo móvel ou PC.

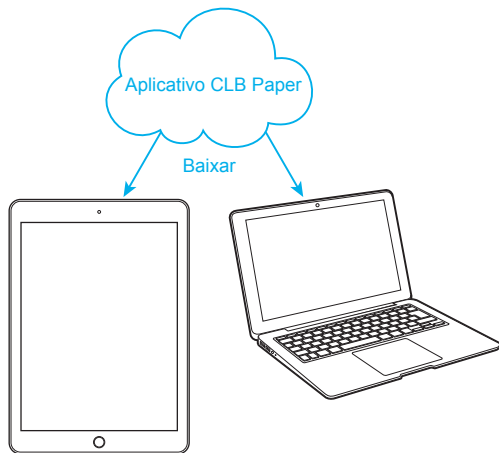

Modo Bluetooth

1. Deslize o interruptor para o modo BT

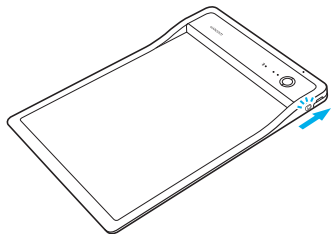

3. Pressione o botão liga desliga para ligar o PHU-111

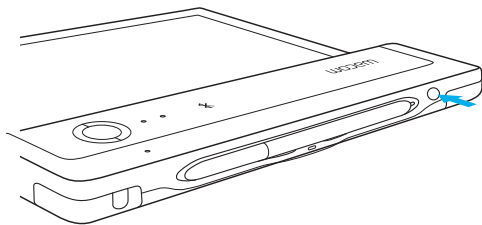

2. Carregue o PHU-111 por, no mínimo, 2 horas

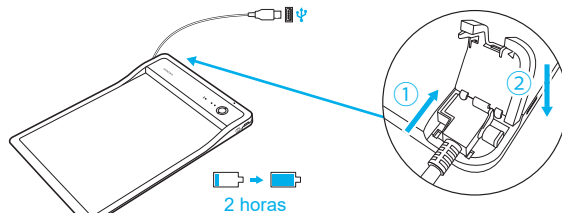

4. Abra o aplicativo CLB Paper

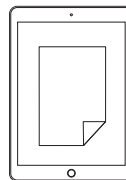

Modo USB

1. Deslize o interruptor para o modo USB

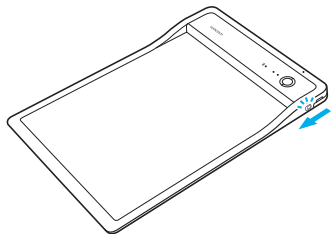

2. Conecte o PHU-111 a um PC através da USB

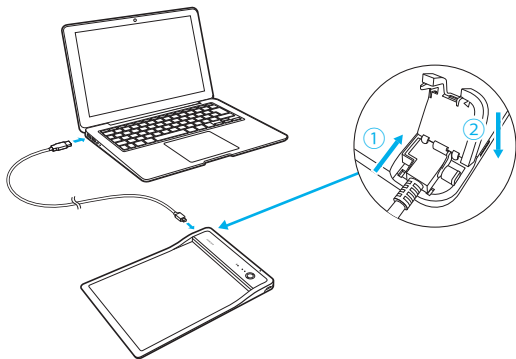

3. Abra o aplicativo CLB Paper

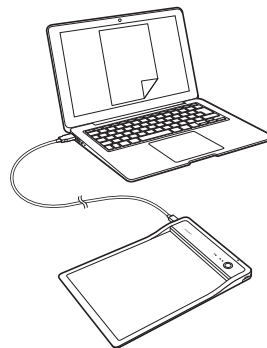

Introdução ao CLB Paper

- Abra o clipe e insira seu documento

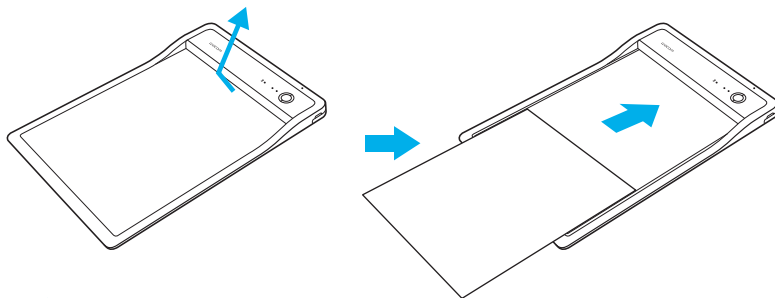

Alinhe seu documento com o canto superior esquerdo do PHU-111

- Confirme se o documento correto aparece em seu dispositivo móvel ou PC

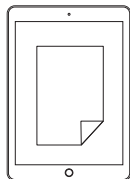

- Pressione o botão Iniciar para iniciar o aplicativo
Comece a escrever quando o LED de status do aplicativo acender

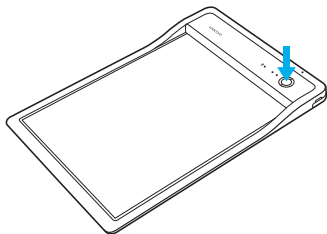

- Quando o documento estiver pronto, pressione o botão Concluir

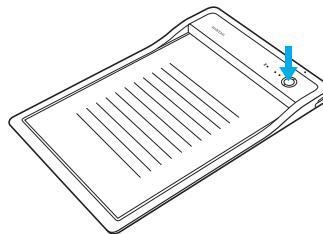

Uma alerta soará se você começar a escrever antes que o aplicativo esteja pronto.

Começando a usar a Wacom Clipboard

<http://business.wacom.com/start>

Suporte Wacom / Serviço de atendimento ao cliente Wacom

Para obter suporte para registrar seu produto, acesse wacom.com e clique em "Suporte".

© 2017 Wacom Co., Ltd. Todos os direitos reservados.

Wacom e seu logo são marcas comerciais e/ou marcas comerciais registradas da Wacom Co., Ltd.

Akcesoria znajdujące się w zestawie



Uwiesz na pióro

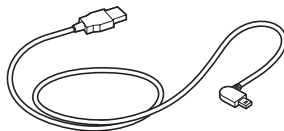

Przewód USB (3 m)

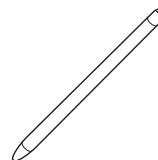

Pióro

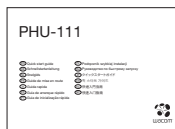

Podręcznik szybkiej instalacji



Wkład atramentowy



Narzędzie do wyjmowania wkładów

Zapoznanie się z produktem

1. Dioda LED stanu Bluetooth
2. Dioda LED stanu aplikacji
3. Głośnik
4. Dioda LED stanu akumulatora
5. Przycisk uruchomienia / zakończenia
6. Strefa papieru
7. Selektor trybu USB/BT

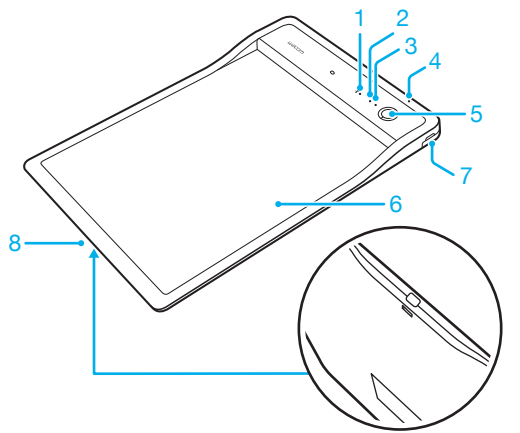

8. Otwór uwięzi na pióro
9. Pokrywa gniazda USB
10. Schowek na pióro
11. Przycisk zasilania
12. Złącza ładowania

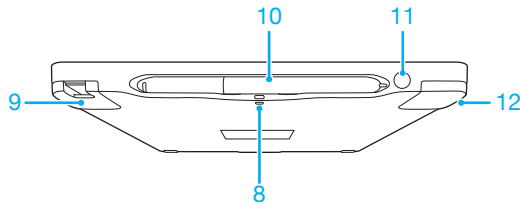

Wskaźnik diodowy

1. Dioda LED stanu akumulatora (pomarańczowy)

Niski poziom energii	Miganie wolne
Ładowanie	Miganie szybkie
Bateria naładowana	Wł.

2. Dioda LED stanu Bluetooth (niebieski)

Parowanie	Miganie
Sparowano	Wł.

3. Dioda LED stanu aplikacji (zielony)

Gotowość	Wł.
Brak gotowości	Off (Wył.)

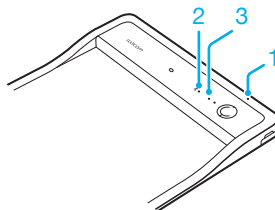

Schówek i uwięź na pióro

- Pióro należy przechowywać w schowku.

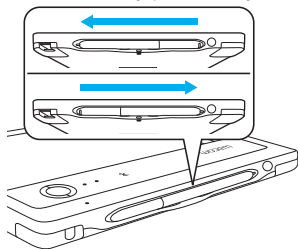

- Otwór uwięzi na pióro

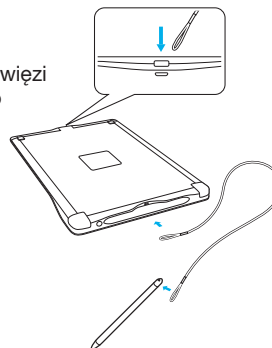

Rozpoczęcie korzystania z urządzenia mobilnego lub komputera

- Pobierz aplikację CLB Paper na urządzenie mobilne lub komputer.

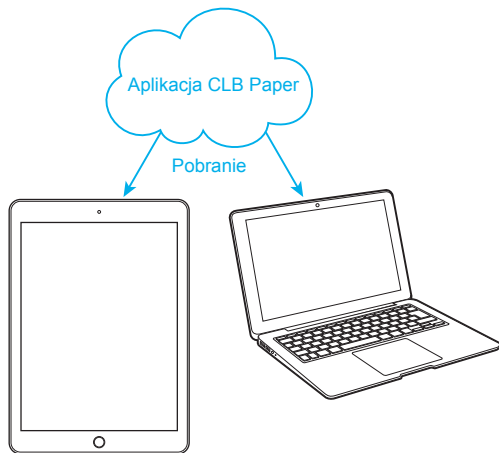

Tryb Bluetooth

1. Przesuń przełącznik na tryb BT

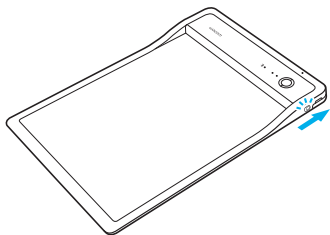

3. Naciśnij przycisk zasilania, aby włączyć urządzenie PHU-111

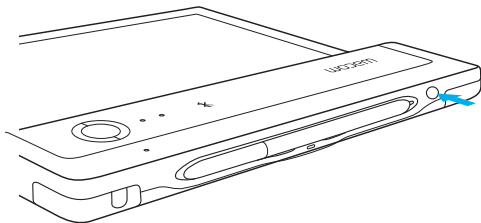

2. Ładuj urządzenie PHU-111 przez co najmniej 2 godziny

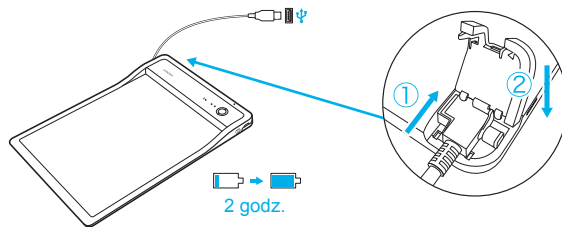

4. Otwórz aplikację CLB Paper

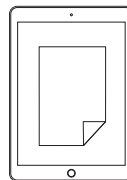

Tryb USB

1. Przesuń przełącznik na tryb USB

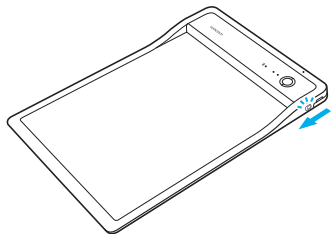

2. Podłącz urządzenie PHU-111 do komputera za pomocą USB

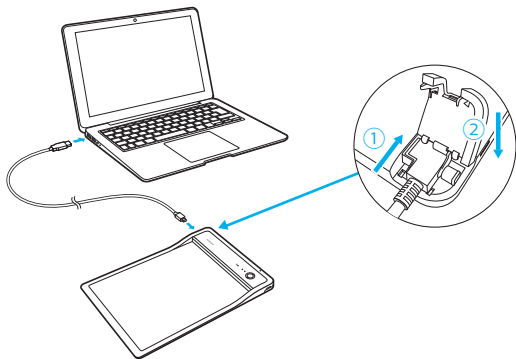

3. Otwórz aplikację CLB Paper

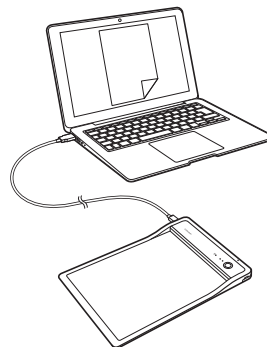

Rozpoczęcie korzystania z aplikacji CLB Paper

- Otwórz zatrzask i wsuń dokument

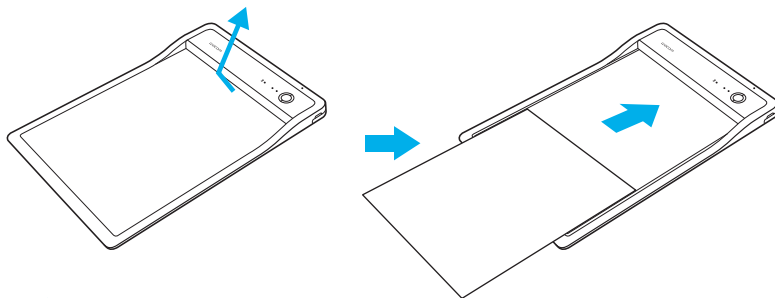

Wyrównaj dokument z lewym górnym rogiem urządzenia PHU-111

- Potwierdź, że prawidłowy dokument jest widoczny na urządzeniu przenośnym lub komputerze

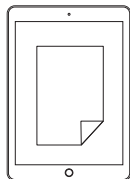

- Naciśnij przycisk uruchomienia, aby uruchomić aplikację
Rozpocznij pisanie, gdy dioda LED stanu aplikacji świeci się

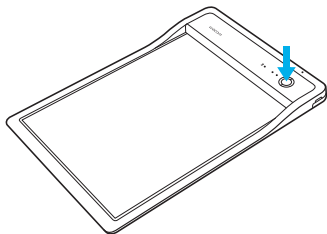

- Gdy dokument jest gotowy, naciśnij przycisk zakończenia

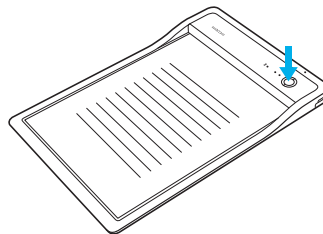

Jeśli zaczniesz pisać zanim aplikacja będzie gotowa, to rozlegnie się alarm dźwiękowy.

Aby rozpocząć pracę z rysikiem Wacom Clipboard

<http://business.wacom.com/start>

Pomoc Wacom / dział obsługi klienta Wacom

Aby zarejestrować swój produkt i uzyskać pomoc techniczną, przejdź do witryny wacom.com i kliknij łącze Support (Pomoc).

© 2017 Wacom Co., Ltd. Wszelkie prawa zastrzeżone.

Wacom oraz odpowiednie logo są znakami handlowymi i/lub zastrzeżonymi znakami handlowymi firmy Wacom Co., Ltd.

Поставляемые принадлежности



Шнур пера

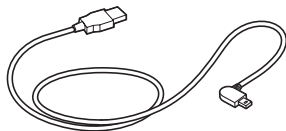

USB-кабель (3 м)

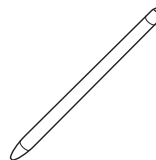

Перо

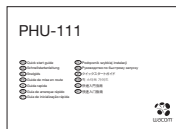

Руководство по
быстрому запуску



Чернильный
картридж



Пинцет для
замены наконечника

Знакомство с устройством

1. Светодиодный индикатор состояния Bluetooth
2. Светодиодный индикатор состояния приложения
3. Динамик
4. Светодиодный индикатор состояния батареи
5. Кнопка Начать/ Завершить
6. Зона для бумаги
7. Переключатель режима USB/Bluetooth

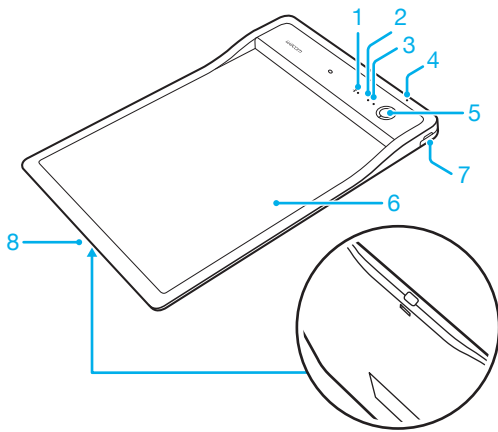

8. Отверстие для шнура пера
9. Крышка USB-разъем
10. Отсек пера
11. Кнопка питания
12. Зарядные контакты

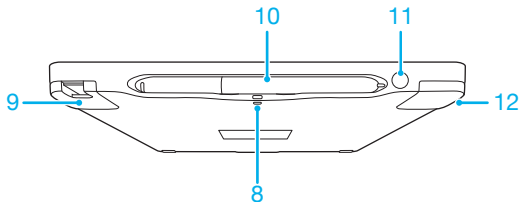

Светодиодный индикатор

1. Светодиодный индикатор состояния батареи (оранжевый)

Низкий уровень заряда	Мигает медленно
Зарядка	Мигает быстро
Батарея заряжена	Включен

2. Светодиодный индикатор состояния Bluetooth (синий)

Соединение	Мигает
Сопряжение установлено	Включен

3. Светодиодный индикатор состояния приложения (зеленый)

Готово	Включен
Не готово	Отключен

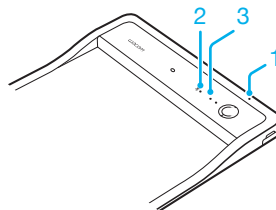

Отсек для хранения пера и шнура пера

- Держите перо в отсеке для хранения.

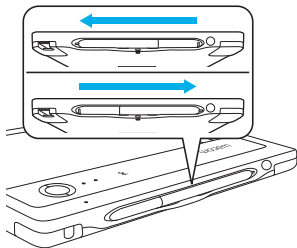

- Отверстие для шнура пера



Начало работы с мобильным устройством или ПК

- Загрузите приложение CLB Paper на ваше мобильное устройство или ПК.

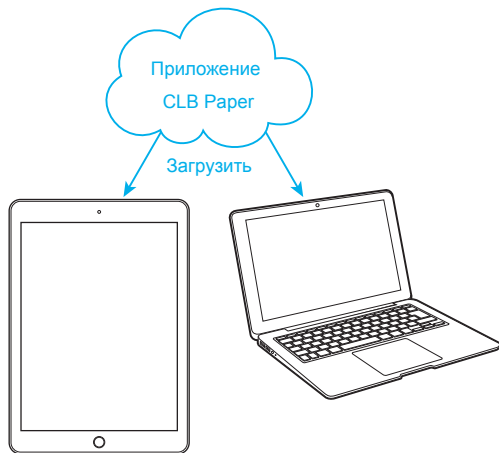

Режим Bluetooth

1. Передвиньте переключатель в режим Bluetooth

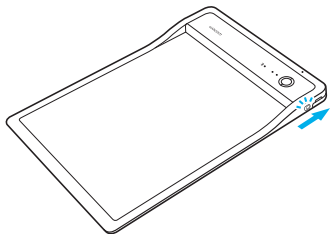

3. Нажмите кнопку питания, чтобы включить PDU-111

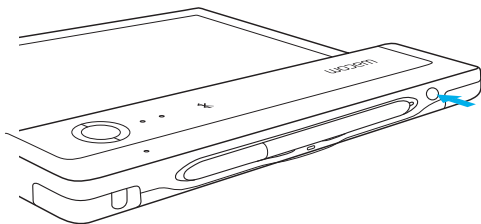

2. Заряжайте PDU-111 не менее 2 ч

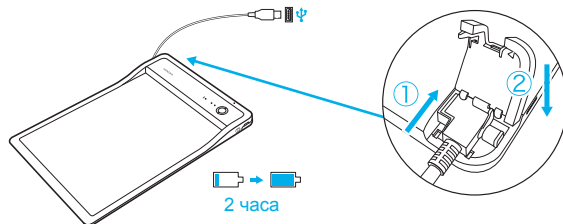

4. Откройте приложение CLB Paper

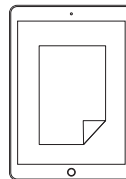

RU

Режим USB

1. Передвиньте переключатель в режим USB

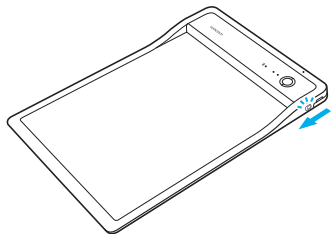

2. Подсоедините PNU-111 к ПК через USB

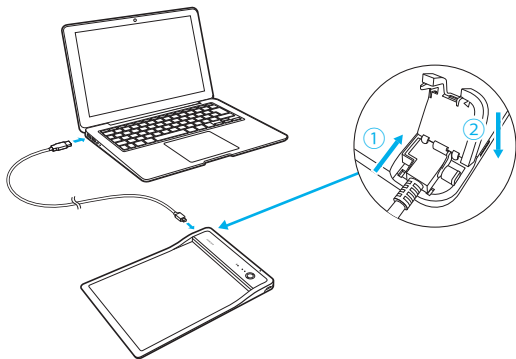

3. Откройте приложение CLB Paper

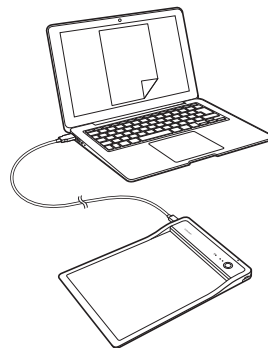

Знакомство с CLB Paper

- Откройте зажим и вставьте документ

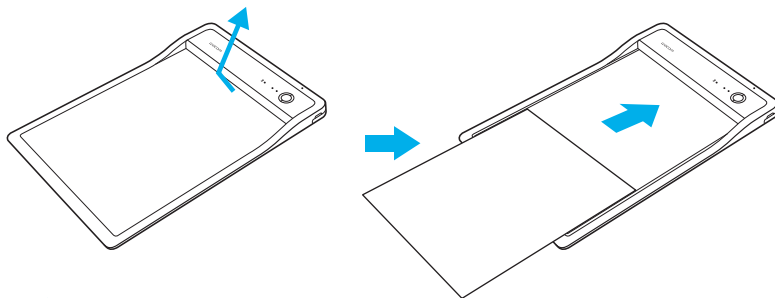

Расположите документ так, чтобы его левый верхний угол совпадал с РНУ-111

- Подтвердите, что на вашем мобильном устройстве или ПК появился необходимый документ

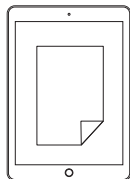

- Нажмите кнопку «Начать» для начала работы приложения
Начинайте писать после того, как загорится светодиодный индикатор состояния приложения

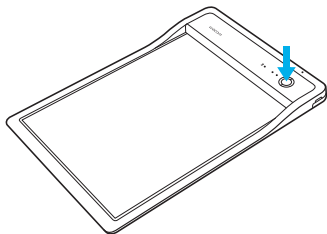

- Когда документ закончен, нажмите кнопку «Завершить»

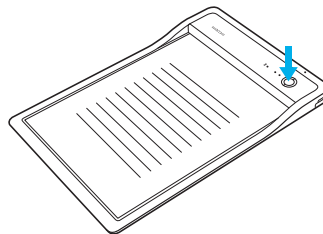

Если вы начали писать прежде, чем приложение приступило к работе, раздастся предупредительный сигнал.

Начало работы с Wacom Clipboard

<http://business.wacom.com/start>

Поддержка Wacom / Сервисная служба Wacom

Для получения технической поддержки и регистрации устройства перейдите на веб-сайт wacom.com и выберите раздел «Поддержка».

© 2017 Wacom Co., Ltd. Все права защищены.

Wacom и соответствующий логотип являются товарными знаками/зарегистрированными товарными знаками Wacom Co., Ltd.

付属品



ペン紛失防止ケーブル

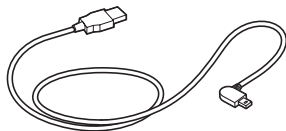

USBケーブル (3m)

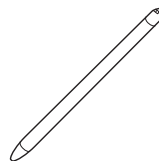

ペン

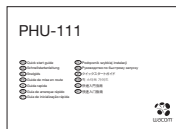

クイックスタートガイド (本書)



インクカートリッジ



芯抜き

この製品について

1. Bluetoothステータスランプ
2. アプリケーションステータスランプ
3. スピーカー
4. 電池ステータスランプ
5. 開始/終了ボタン
6. 用紙領域
7. USB/BTモードセレクト
8. ペン紛失防止ケーブル取り付け穴
9. USBプラグカバー
10. ペンコンパートメント
11. 電源ボタン
12. 充電用ソケット

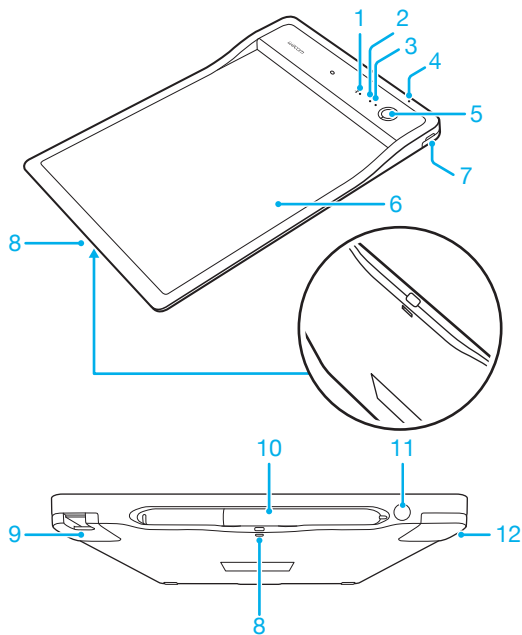

表示ランプ

1. 電池ステータスランプ (オレンジ)

残量低下	ゆっくり点滅
充電中	短い間隔で点滅
バッテリー充電済み	オン

2. Bluetoothステータスランプ (青)

ペアリング中	点滅
ペアリング完了	オン

3. アプリケーションステータスランプ (緑)

準備完了	オン
準備中	オフ

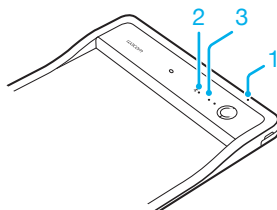

ペンホルダーとペン紛失防止ケーブル

- コンパートメントにペンを収納します。

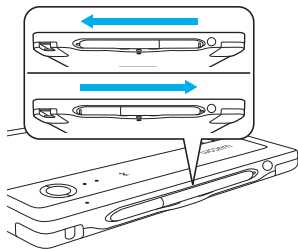

- ペン紛失
- 防止ケーブル
- 取り付け穴

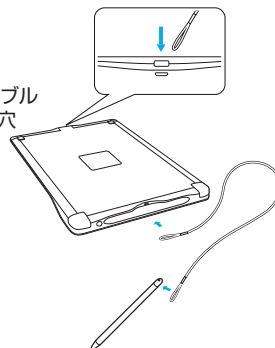

モバイル機器やPCで使用

- CLB Paperアプリケーションをモバイル機器やPCにダウンロードします。

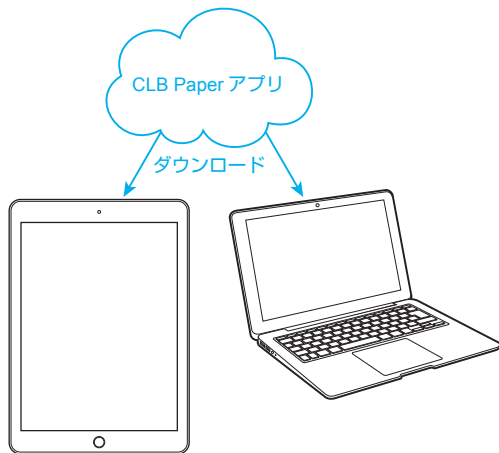

Bluetooth モード

1. スイッチをスライドしてBTモードに移動します。

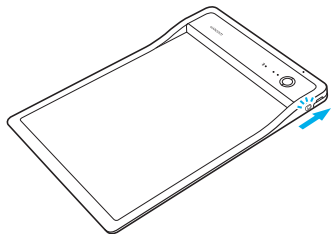

3. 電源ボタンを押して、PHU-111 をオンにします。

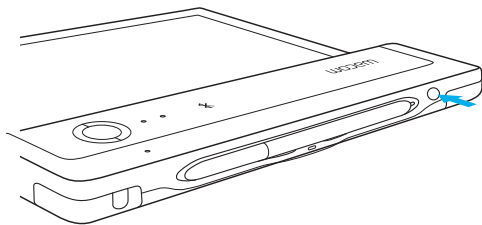

2. 最低2時間PHU-111を充電します。

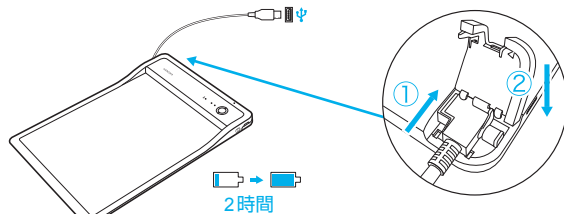

4. CLB Paperアプリケーションを開きます。

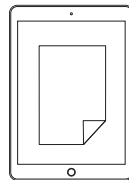

USBモード

1. スイッチをスライドしてUSBモードに移動します。

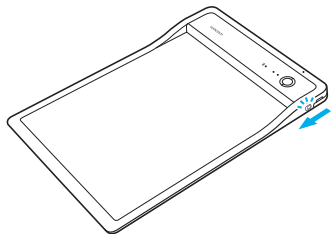

2. USBケーブルを使用して、PHU-111をPCに接続します。

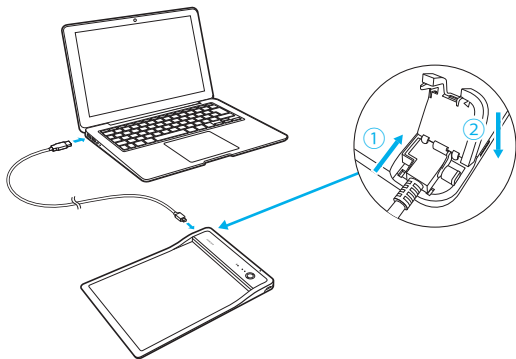

3. CLB Paperアプリケーションを開きます。

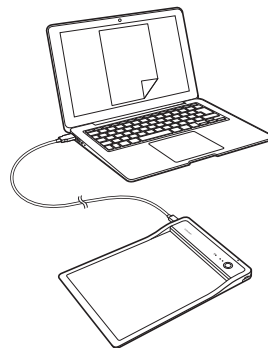

CLB Paperの使用方法

- クリップを開き、用紙を挿入します。

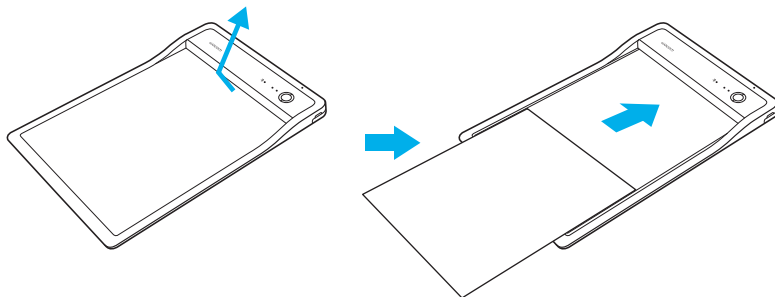

PHU-111の左上隅に用紙を合わせます。

- モバイル機器やPCに用紙が正しく表示されるか確認します。

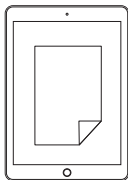

- 開始ボタンを押し、アプリケーションを始めます。
アプリケーションステータスランプがオンになったら、書き始めます。

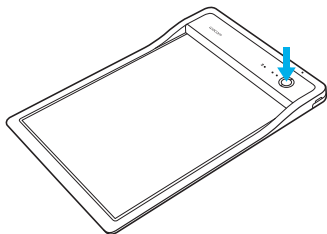

- 文書が完成したら、終了ボタンを押します。

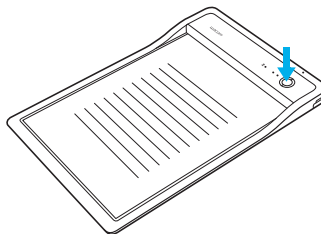

アプリケーションの準備ができる前に書き始めると、警告がなります。

JP

Wacom Clipboard の使い方について

<http://business.wacom.com/start>

Wacom サポート / Wacom カスタマーサービス

製品のサポートと登録については、wacom.com にアクセスし、「サポート」をクリックしてください。

© 2017 Wacom Co., Ltd. All rights reserved.

Wacom および関連するロゴは、株式会社ワコムの商標または登録商標です。

제공 액세서리



펜 연결 끈

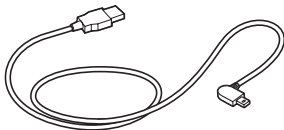

USB 케이블 (3m)



펜



퀵 스타트 가이드



잉크 카트리지



펜심 제거 도구

제품 살펴보기

1. Bluetooth 상태 LED
2. 응용 프로그램 상태 LED
3. 스피커
4. 배터리 상태표시 LED
5. 시작 / 종료 버튼
6. 종이 영역
7. USB/BT 모드 선택기
8. 펜 연결 끈 구멍
9. USB 플러그 커버
10. 펜 보관함
11. 전원 버튼
12. 충전 접점

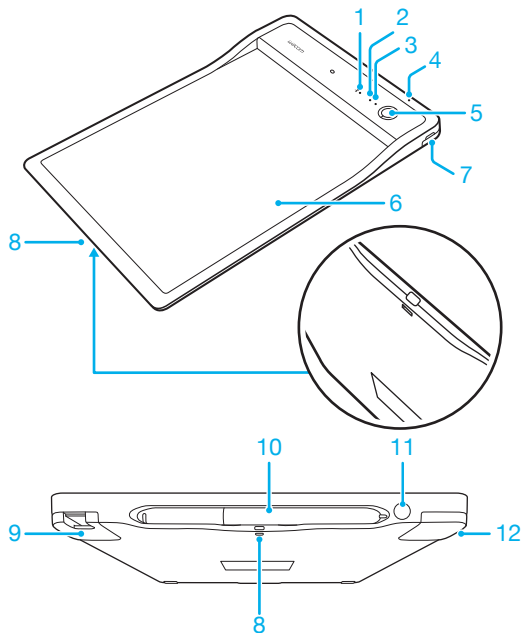

LED 표시기

1. 배터리 상태 LED(주황색)

배터리 부족	천천히 깜박임
충전 중	빨리 깜박임
배터리 충분	켜짐

2. Bluetooth 상태 LED(파란색)

페어링 중	깜박임
페어링됨	켜짐

3. 응용 프로그램 상태 LED(녹색)

준비됨	켜짐
준비 안 됨	꺼짐

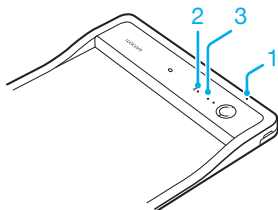

펜 보관함 및 펜 연결 끈

- 펜을 보관함에 보관하십시오.

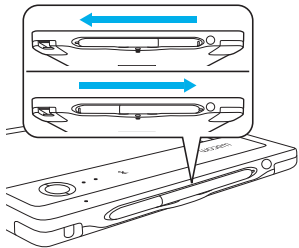

- 펜 연결 끈 구멍

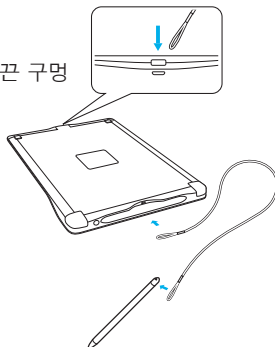

모바일 기기 또는 PC 시작하기

- CLB Paper 응용 프로그램을 모바일 기기나 PC 로 다운로드하십시오 .

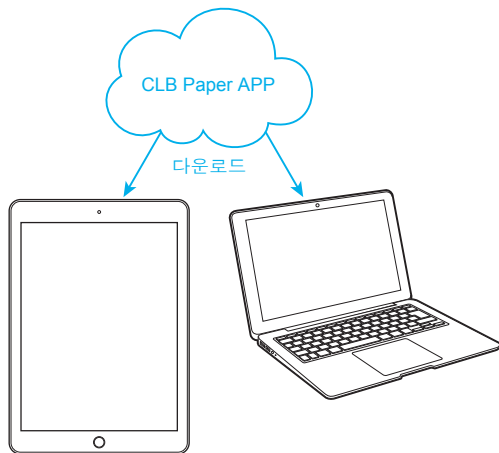

Bluetooth 모드

1. 스위치를 BT 모드로 이동하십시오.

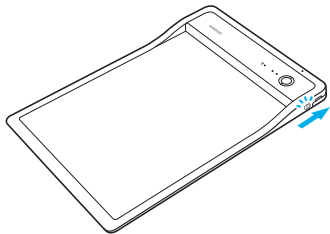

3. 전원 버튼을 눌러 PHU-111 을 켜십시오.

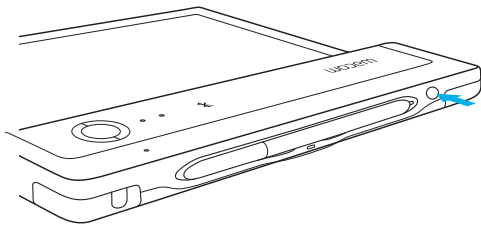

2. PHU-111 을 최소 2 시간 동안 충전하십시오.

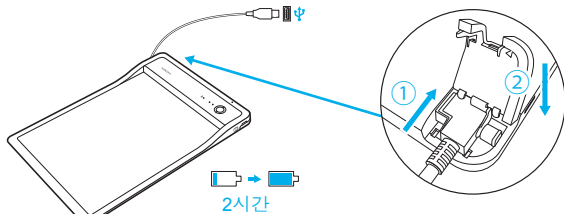

4. CLB Paper 응용 프로그램을 여십시오.

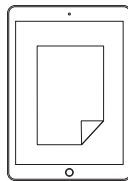

USB 모드

1. 스위치를 USB 모드로 이동하십시오.

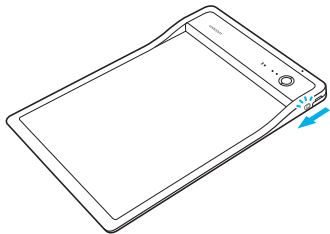

2. USB 를 통해 PHU-111 을 PC 에 연결하십시오 .

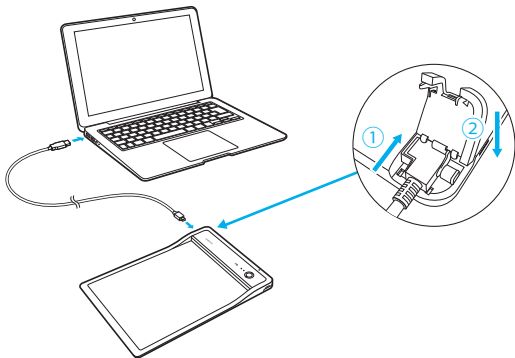

3. CLB Paper 응용 프로그램을 여십시오 .

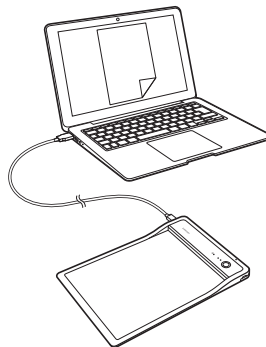

CLB Paper 시작하기

- 클립을 열고 문서를 넣으십시오.

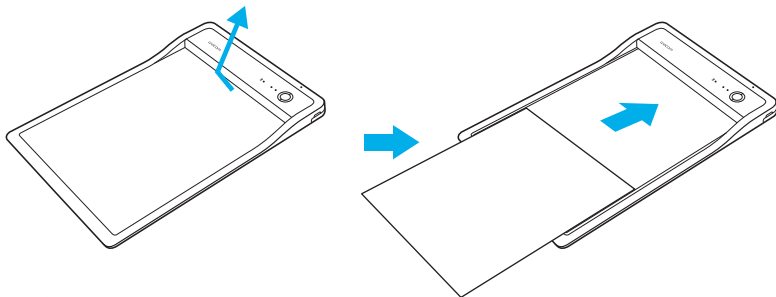

문서를 PHU-111의 왼쪽 위 모서리에 맞추십시오.

- 모바일 기기나 PC에 올바른 문서가 나타나는지 확인하십시오.

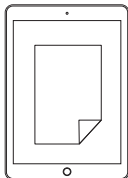

- 시작 버튼을 눌러 응용 프로그램을 시작하십시오.
응용 프로그램 상태 LED가 켜지면 쓰기 시작하십시오.

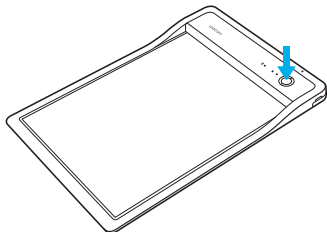

- 문서가 완성되면 종료 버튼을 누르십시오.

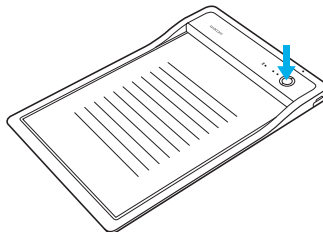

응용 프로그램이 준비되기 전에 쓰기 시작하면 경고음이 울립니다.

KR

Wacom Clipboard 을 시작하려면 다음을 따르세요

<http://business.wacom.com/start>

Wacom 지원 / Wacom 고객 서비스

제품의 지원 및 등록에 관한 내용을 보려면 wacom.com 에서 Support(지원) 를 클릭하십시오.

© 2017 Wacom Co., Ltd. All rights reserved.

Wacom 및 해당 로고는 Wacom Co., Ltd. 의 상표 및 / 또는 등록 상표입니다.

隨附配件



筆繩

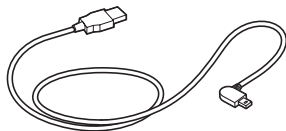

USB連接線 (3公尺)

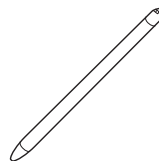

數位筆

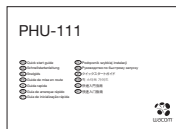

快速入門指南



墨水匣



筆尖更換夾

認識產品

1. 藍牙狀態指示燈
2. 應用程式狀態指示燈
3. 喇叭
4. 電池狀態指示燈
5. 開始/完成按鈕
6. 紙張區域
7. USB/藍牙模式選擇開關
8. 數位筆繩孔
9. USB插孔蓋
10. 數位筆收納槽
11. 電源開關
12. 充電觸點

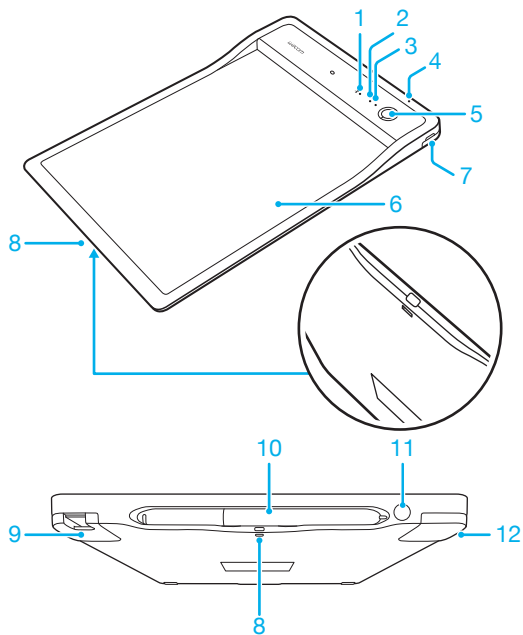

LED指示燈

1. 電池狀態指示燈（橘色）

低電量	緩慢閃爍
正在充電	快速閃爍
電池充滿	恆亮

2. 藍牙狀態指示燈（藍色）

正在配對	閃爍
已配對	恆亮

3. 應用程式狀態指示燈（綠色）

就緒	恆亮
未就緒	熄滅

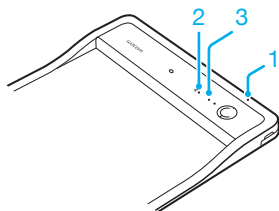

數位筆儲存空間和筆繩

- 請將數位筆置於收納槽中。

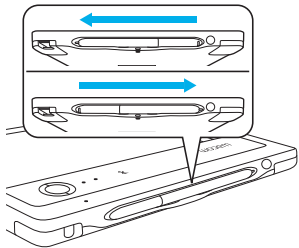

- 數位筆繩孔

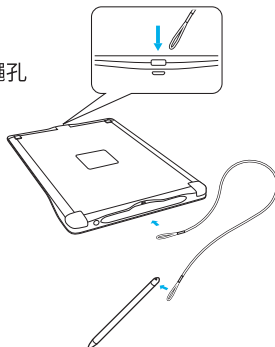

搭配行動裝置或電腦開始使用

- 將CLB Paper應用程式下載到行動裝置或電腦。

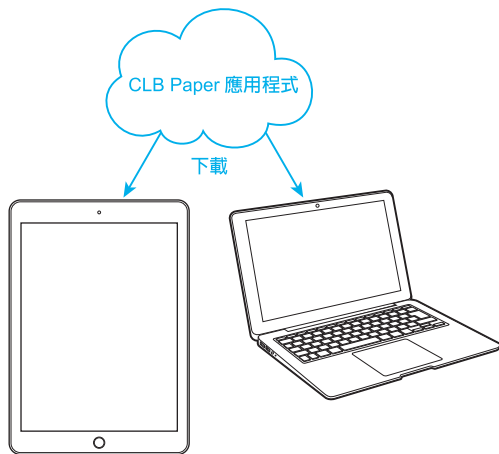

藍牙模式

1. 將開關切換至藍牙模式

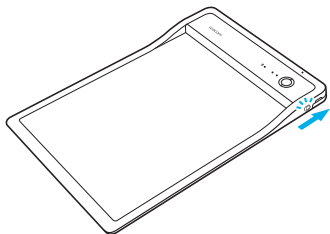

3. 按下電源按鈕以啟動PHU-111

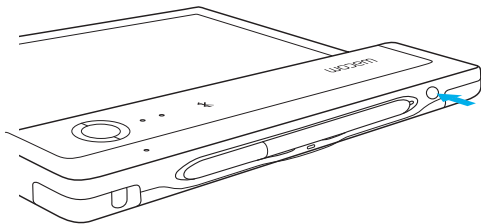

2. 將PHU-111充電至少2小時

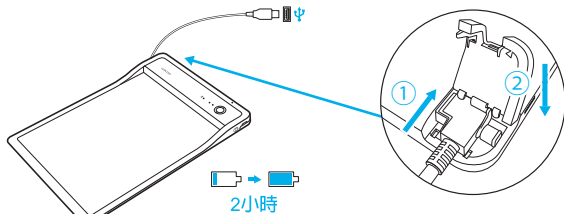

4. 開啟CLB Paper應用程式

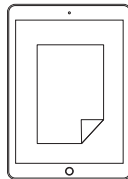

USB 模式

1. 將開關切換至USB模式

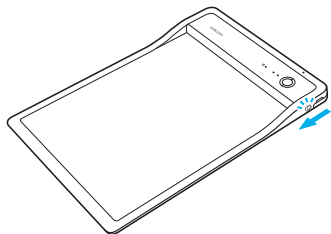

2. 透過USB將PHU-111連線至電腦

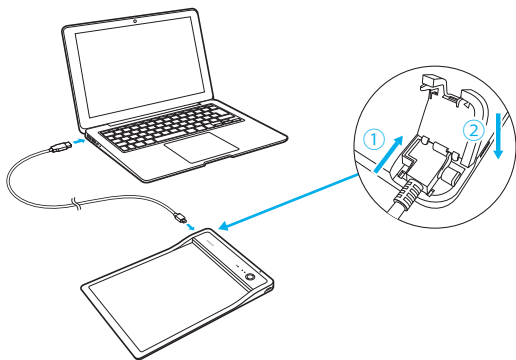

3. 開啟CLB Paper應用程式

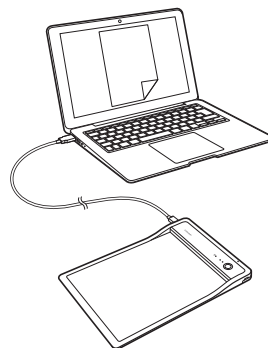

開始使用CLB Paper

- 打開紙夾並置入文件

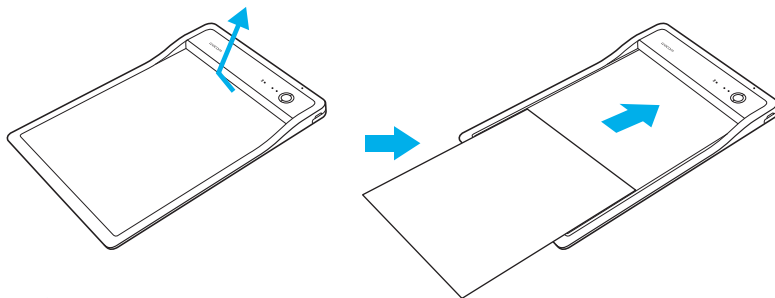

將文件對齊PHU-111左上角

- 確認文件已正確顯示在行動裝置或電腦上

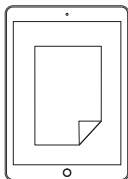

- 按下開始按鈕以啟動應用程式
應用程式指示燈亮起時開始書寫

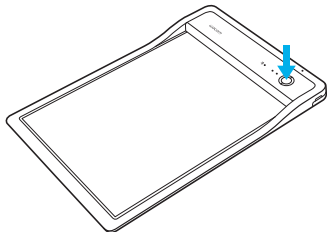

- 完成文件後，按下完成按鈕

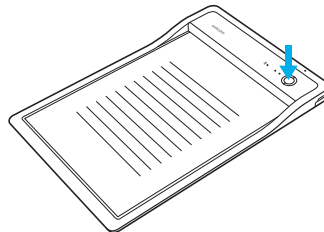

在應用程式尚未就緒時書寫，將會響起警示音。

開始使用Wacom Clipboard

<http://business.wacom.com/start>

Wacom支援 / Wacom客服中心

如需支援或註冊產品請至wacom.com並按一下「支援」。

© 2017 Wacom Co., Ltd. 保留所有權利。
Wacom及其標誌均為Wacom Co., Ltd.的註冊商標。

随附配件



笔绳

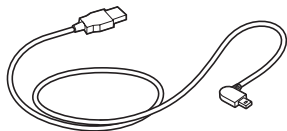

USB 连接线 (3 米)

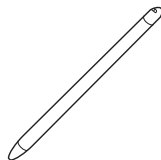

笔

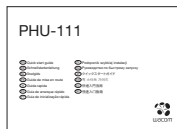

快速入门指南



墨水芯



笔尖拆卸工具

了解产品

1. 蓝牙状态指示灯
2. 应用状态指示灯
3. 扬声器
4. 电池状态指示灯
5. “开始 / 完成” 按钮
6. 纸张区域
7. USB/BT 模式选择器
8. 笔绳孔
9. USB 插头盖
10. 笔仓
11. 电源按钮
12. 充电触点

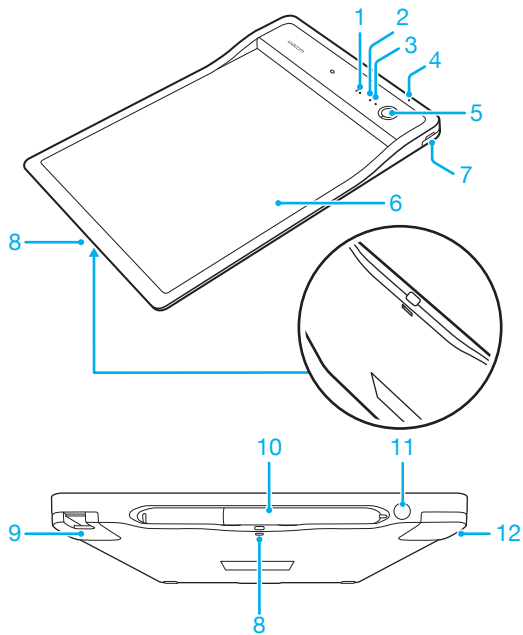

LED 指示灯

1. 电池状态指示灯（橙色）

电量低	慢速闪烁
充电中	快速闪烁
充满电	亮起

2. 蓝牙状态指示灯（蓝色）

配对	闪烁
已配对	亮起

3. 应用状态指示灯（绿色）

准备就绪	亮起
未准备就绪	关

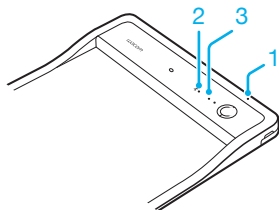

笔仓和笔绳

- 笔应放置在笔仓中。

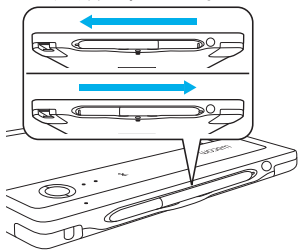

- 笔绳孔

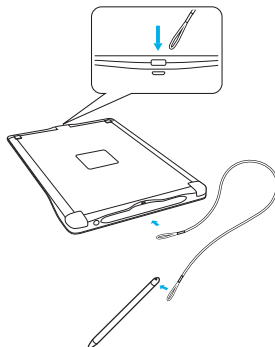

移动设备或 PC 使用入门

- 将 CLB Paper 应用程序下载到您的移动设备或 PC 上。

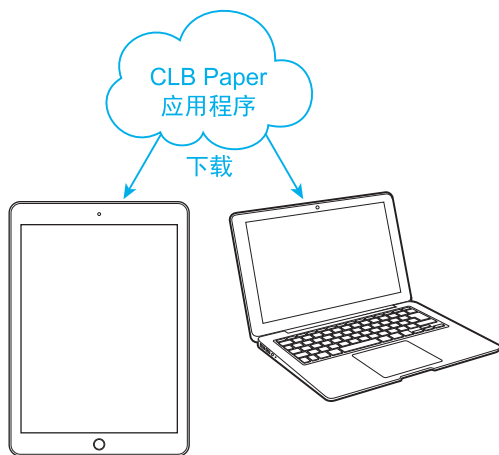

蓝牙模式

1. 将开关滑动到 BT 模式

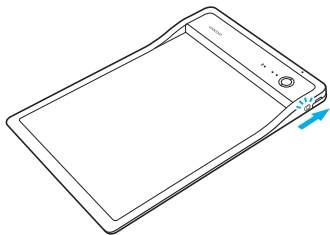

3. 按下电源按钮，开启 PHU-111

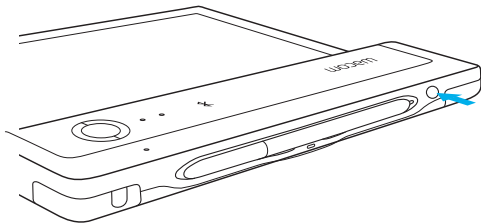

2. 为 PHU-111 充电至少 2 小时

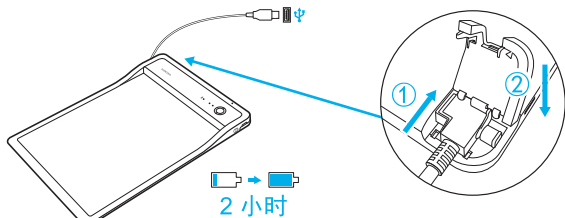

4. 打开 CLB Paper 应用程序

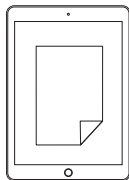

USB 模式

1. 将开关滑动到 USB 模式

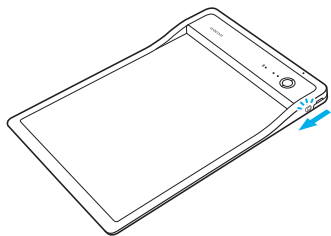

2. 通过 USB 将 PHU-111 连接到 PC

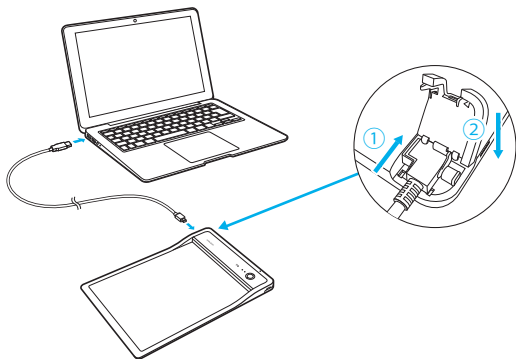

3. 打开 CLB Paper 应用程序

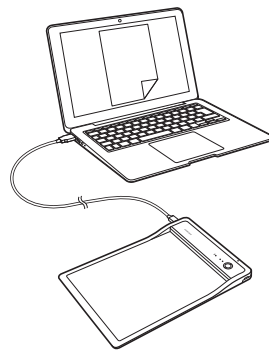

CLB Paper 使用入门

- 打开卡子，插入文档

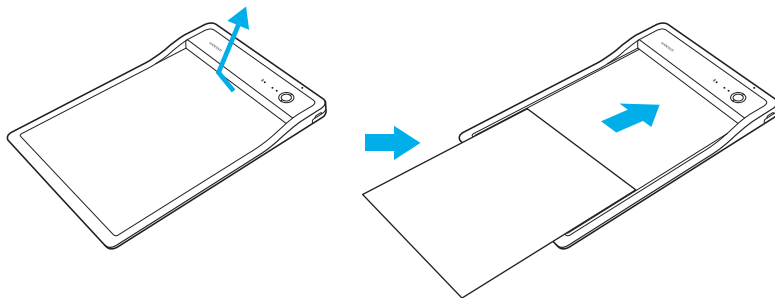

将文档与 PHU-111 左上角对齐

- 确认您的移动设备或 PC 上显示正确的文档

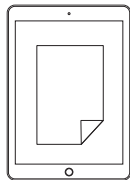

- 按下“开始”按钮，启动应用程序
应用状态指示灯亮起时，开始书写

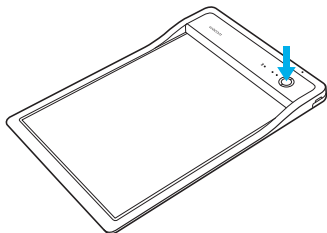

- 文档完成后，按下“完成”按钮

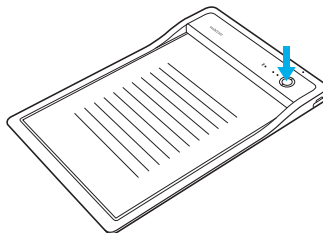

如果在应用程序准备就绪前开始书写，将发出警告音。

要开始使用 Wacom Clipboard

<http://business.wacom.com/start>

SC Wacom 支持 / Wacom 客户服务

如需支持并注册您的产品，请转至 wacom.com，然后点击“支持”。

请保留此文件以便将来查看。

© 2017 Wacom Co., Ltd. 保留所有权利。
Wacom 及其图标是 Wacom Co., Ltd. 的商标和 / 或注册商标。

wacom®